



Cosmo Pricebook

August 2024

Contract Number: 5610A – Solicitation
#DPC-926634448-BAJ - Furniture

Contents

Overview	v
the line-up	vi
product overview	x
features and benefits	xi
variable height panel combinations	xii
maximum span of panels	xiii
electrical cable length calculation	xiv
storage capacity and handle options	xv
Panel Frames	18
panel frame	20
panel frame for full acrylic panel	22
panel frame with countertop capability	24
panel frame with flip-up capability	26
stack-on panel frame	28
panel door	30
acrylic sliding door	31
lockable acrylic sliding door	32
end trim	33
wall-to-panel connector	34
t-connection filler	36
90-degree filler	37
180-degree connection filler	38
135-degree 2-way connector	39
120-degree 2-way connection filler	40
120-degree 3-way connection filler	42
4-way connection filler	43
floor grippers	44
Tiles	46
acoustic tackable fabric tile	48
monolithic fabric tile	52
acrylic tiles	56
magnetic whiteboard tile	59
laminated tile	60
monolithic laminated tile	62
monolithic laminated tile	64
perforated metal tile	68
pass-through tile	70
fabric flip-up belt-line tile	71
accessory tile	72

Worksurfaces	74
straight worksurface	76
straight worksurface with power grommet	80
wave return with straight end	82
wave return with curved end	86
extended corner with curved front	90
angled worksurface with curved front	92
flexed worksurface with curved front	94
5-sided corner worksurface with straight front	96
5-sided corner worksurface with curved front	98
6-sided corner worksurface	99
panel-mounted d-table	100
panel-mounted p-table	102
panel-mounted j-table	104
panel-mounted y-table	106
c-table extension	108
u-table extension	109
bridge worksurface	110
radiused extended surface	112
tempered glass transaction top	113
laminated countertop	114
Worksurface Supports	118
cantilever arm	120
universal bracket	121
single post	122
horizontal surface support	123
laminated gable	124
intermediate gable	125
open metal gable	126
Mounted Storage	128
panel-mounted flipper cabinet	130
suspended flipper cabinet	132
wall mounted flipper cabinet	134
top mounted shared open shelf	136
cubby storage	138
open metal shelf	139
overhead back bracket	140
double channel wall mount bracket kit	141

Freestanding Storage	142
mobile pedestal	144
mobile pedestal with seat	145
freestanding pedestal	146
freestanding joined pedestal	147
freestanding lateral file	148
freestanding lateral file	149
closed storage tower	150
open storage tower with wardrobe	151
closed storage tower with closet	152
file/file/file storage tower	153
single door storage cabinet	154
double door storage tower	156
combination cabinet	157
Storage	158
end gable pedestal	160
underdesk pedestal	161
underworksurface open shelf	162
underdesk joined pedestal	163
underdesk lateral file	164
underdesk storage cabinet	165
Accessories	166
work organizers	168
accessory bar	169
pencil tray	170
coat hook	171
keyboard tray	172
monitor arm	173
top trim mounted privacy screen	174
wall mounted tackboard	176
worksurface edge mounted screen	180
panel mounted privacy screen	182
Electrics, Communication, Lighting	188
task light	190
power modules	191
electric starter harness	192
monitor arm	193
communication kit	193
power pole	194
belt-line electrics power module	196
horizontal wire manager	197
connector harness	198
male/female extension harness	200

the line-up	vi
product overview	x
features and benefits	xi
variable height panel combinations	xii
maximum span of panels	xiii
electrical cable length calculation	xiv
storage capacity and handle options	xv
Caution	xvi

the line-up

Panel Frames and Connectors

- standard panel frame
- full acrylic panel frame
- countertop capability
- regular stack-on frame
- door stack-on frame
- panel door
- acrylic sliding door
- lockable acrylic sliding door

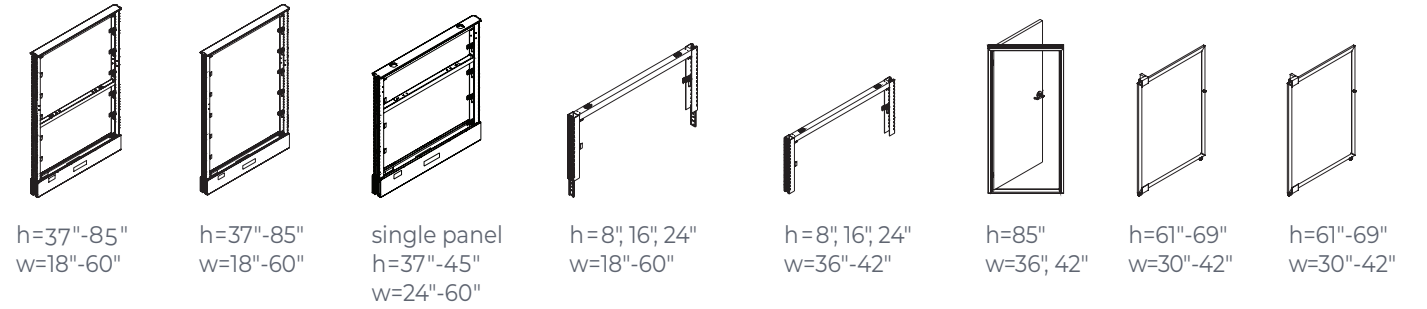

- full end trim
- partial end trim
- full 90° filler
- partial 90° filler
- full 180° connection filler
- partial 180° connector
- full t-connection filler
- partial t-connection filler

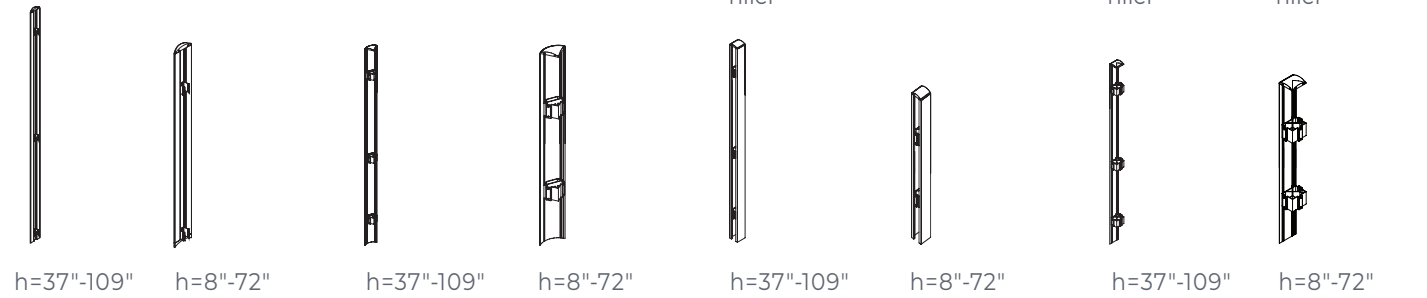

- full 135° 2-way connector
- full 120° 2-way connector
- partial 120° 2-way connector
- full 120° 3-way connector
- full 4-way connector
- wall to panel connector
- floor grippers

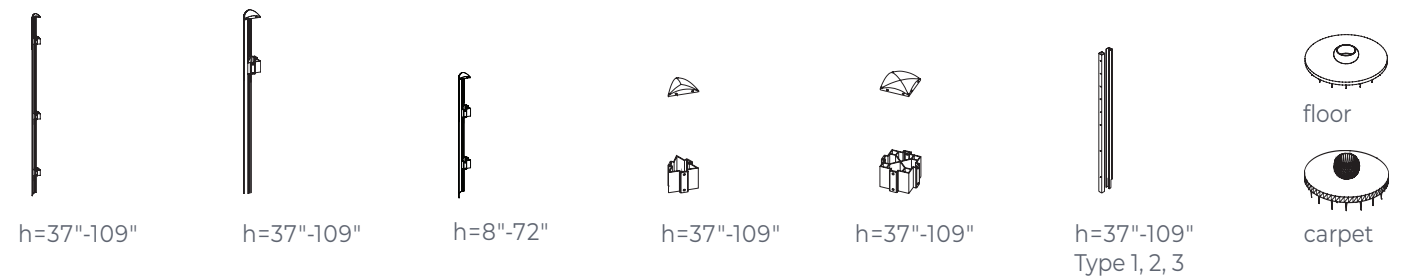

the line-up

Tiles

- acoustic tackable fabric tile
- monolithic fabric tile
- acrylic tile
- lamine tile
- monolithic lamine tile

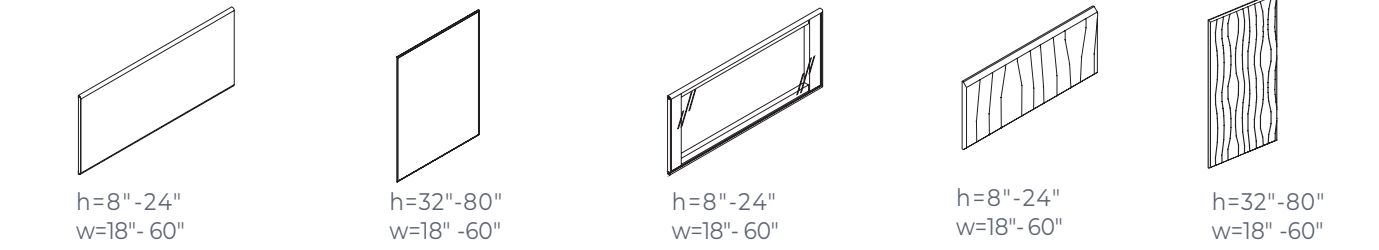

- perforated metal tile
- magnetic whiteboard tile
- accessory tile
- pass-through tile
- belt-line access tile

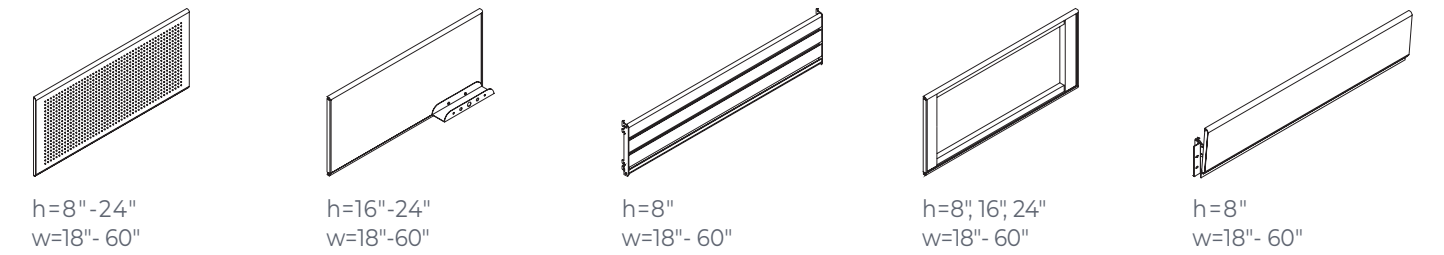

Worksurfaces

- straight worksurface
- straight worksurface
- wave return worksurface
- extended corner with curved front
- 135° worksurface with curved front
- 120° worksurface with curved front

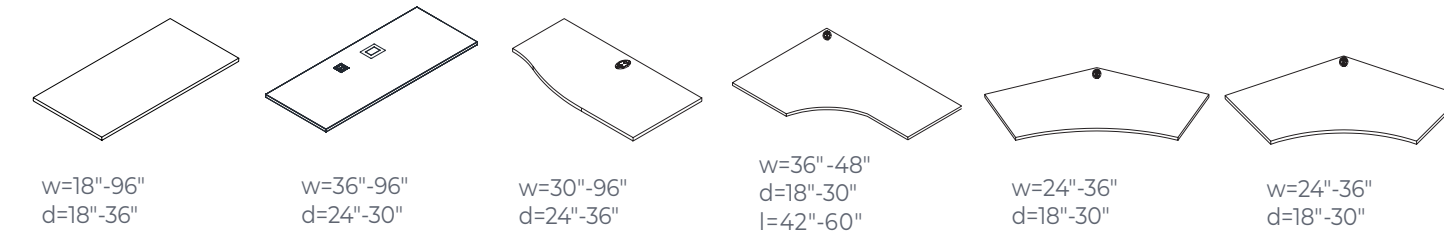





- 5-sided corner worksurface with curved front
- 6-sided corner worksurface
- panel mounted d-table
- j-table
- p-table

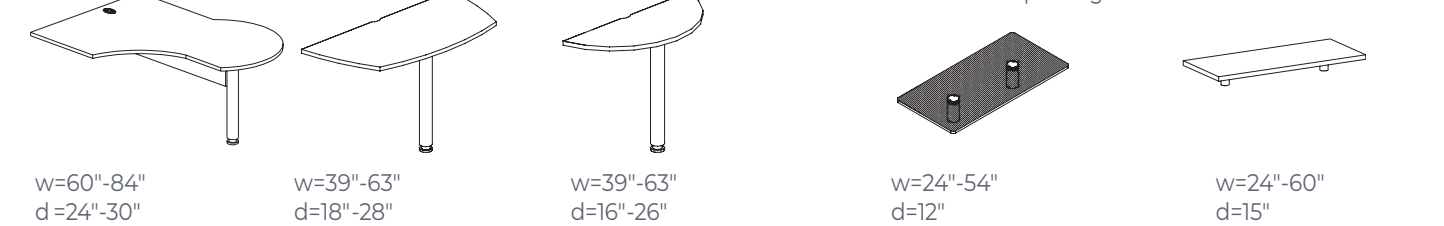

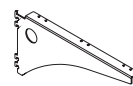
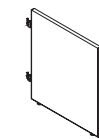
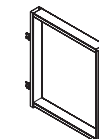

- y-table
- u-table extension
- c-table extension
- tempered glass transaction top-straight
- lamine countertop





Worksurface Supports

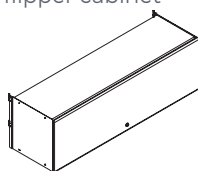
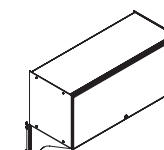
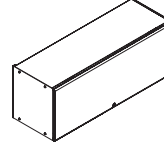
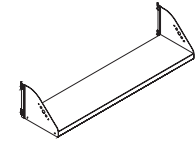

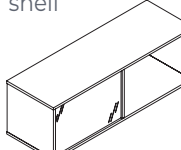
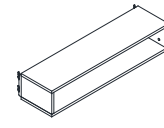
cantilever arm  d=16"-22"	laminated gable  d=12"-36"	open metal gable  d=12"-30"	single post  d=54"-78"	horizontal surface support  d=54"-78"	universal bracket t-kit 
---	---	--	---	---	--

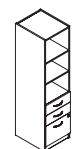
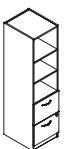
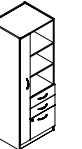
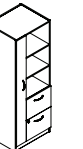
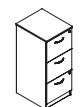
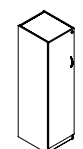
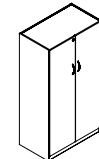
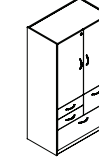
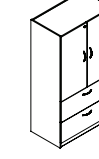
Storage

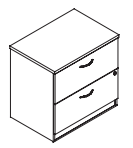
panel-mounted flipper cabinet  w=30"-60" d=14"	suspended flipper cabinet  w=30"-60" d=14"	wall mounted flipper cabinet  w=30"-60" d=14"	open metal shelf  w=24"-60" d=12"	overhead back bracket  w=24"-60"	top mounted shared open shelf  w=30"-87" d=16"	cubby storage  w=24"-48" d=11"
---	--	---	---	--	--	--

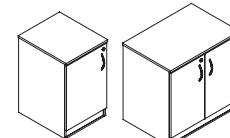
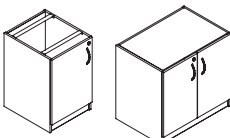
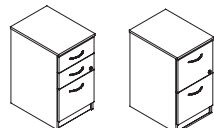
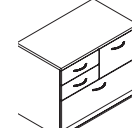

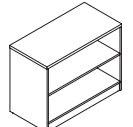
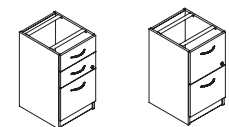
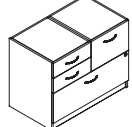
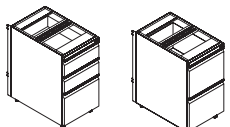
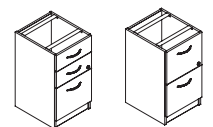

Open Storage Tower		Closed Storage Tower		Storage Tower	Cabinet coat bar	Double cabinet with shelves	Combination cabinet joined pedestal lateral file left-hand	
box/box/file file/file wardrobe wardrobe	file/file wardrobe wardrobe	file/file left-hand left-hand	box/box/file wardrobe wardrobe	file/file/file			file/file	lateral file
								
h=66" w=18" d=21"	h=66" w=24" d=21"	h=66" w=24" d=21"	h=66" w=24" d=21"	h=42" w=18" d=21"	h=66" w=18"-24" d=21"	h=66" w=36" d=21"	h=66" w=36" d=21"	h=66" w=30"-36" d=21"

Freestanding Lateral File Cabinet  h=2, 3, 4 drawer w=30"-42" d=21"	Underdesk Lateral File Cabinet  h=2 drawer w=30"-42" d=21"	Freestanding Cabinet single door double door  w=18"-36" w=30"-36"	Underdesk Cabinet single door double door  w=18"-36" w=30"-36"	Freestanding Pedestal box/box/file file/file  w=16" d=21"	Joined pedestal  w=36" d=21"
---	---	--	--	--	---

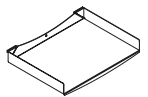

Underdesk Open Shelf  w=24"-96" d=18"	Underdesk pedestal box/box/file file/file  w=16" d=18"	Joined pedestal  w=36" d=21"	Underdesk metal pedestal box/box/file file/file  w=15" d=24", 30"	End Gable pedestal box/box/file file/file  w=16" d=24", 30"	Mobile pedestal box/file  w=17" d=23"	Mobile pedestal with seat box/file  w=17" d=23"
--	---	---	--	---	--	--

Accessories

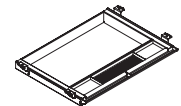

Work Organizers

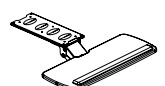
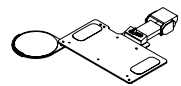
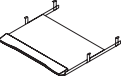
pen holder 	paper sorter 	paper tray 	accessory rail  w = 9", 13"	pencil drawer  w = 18" - 60"
---	---	---	--	---

Ergonomic Accessories

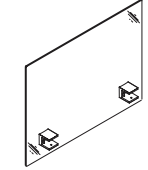
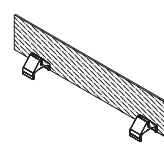
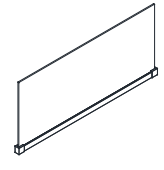

adjustable keyboard tray 	adjustable keyboard tray with mouse 	retractable keyboard tray 	monitor arm single mount 	monitor arm double mount 
---	--	--	---	---

Enhancements

worksurface edge mounted screen  w = 24" - 90" h = 22"	top trim mounted privacy screen  w = 18" - 60" h = 8", 16"	acrylic and glass screen  h = 8" - 16" w = 18" - 60"	coat hook 	hang-on nameplate 
---	---	---	--	--

Electrics, Communication & Lighting

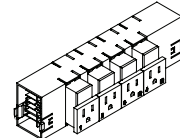
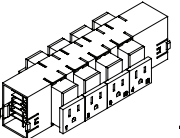
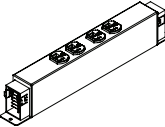
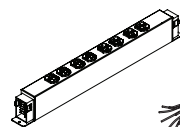
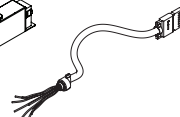
Power & Data

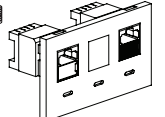
single-sided power base module 	double-sided power base module 	4 outlets belt-line module 	8 outlets belt-line module 	electric starter 	connector harness 	male/female extension 	communications module configuration 1 
				l = 72" or 168"	l = 22" - 181"	l = 44" or 122"	

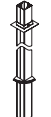
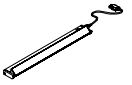
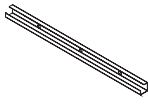
Wire Management	Lighting
power poles  h = 72" - 144"	storage mounted task light  w = 24" - 48"
wire manager  w = 12" - 72"	

product overview



Cosmopolitan is an environment within a workplace. Characterized by a unique upgraded system of segmented and monolithic tiles and streamlined furniture, Cosmopolitan caters to evolving spatial relationships and the modular needs of modern business.

Cosmopolitan's tiles are stackable and are offered in a variety of fabrics and finishes to complement any space.

The hinged access door discreetly conceals electrical wires, opens easily with one hand and stays open while access is required.

Durable laminate worksurfaces in a variety of shapes offer flexibility in space planning and are available in solids, patterns and wood grains with matching vinyl edge trims.

A selection of accessories round out the line, including: whiteboards, pencil drawers, task lighting, paper trays, pencil holders and more.

pedestals

All pedestal drawers are outfitted with full extension slides. Drawers can be easily removed by releasing the small catches on either side of the slide. Pedestals come standard with locks. One lock will lock both file drawers in a file/file pedestal and one box drawer and the file drawer in the box/box/file pedestal. File drawers will accommodate legal or letter sized documents.

freestanding storage and combo cabinets

Various combination filing and storage units provide a place to store personal items and documents to suit any individual's needs.

Cabinets are offered in a variety of solid, pattern and wood grain laminates and are available with or without doors. Cabinets with doors include locks.

default vinyl color selections

Each laminate comes with matching vinyl trim color unless otherwise specified on the purchase order. Refer to the laminate finish card for details.

accessories

Computer accessories include flat screen monitor arms, articulating keyboard trays and CPU holders.

Heavy duty flat screen monitor arms adjust to the user while storing wire within the arm. The monitor arm mounting plate meets VESA standards to accommodate most monitors. Monitor arms can be grommet or clamp mounted to the worksurface. Articulating and retractable keyboard trays and mobile or underdesk mounted CPU holders complete the workstation.

handle details

Six handle options are available in a brushed nickel finish. Melbourne is the standard handle option unless otherwise specified on your purchase order. Handles are five inches in length.

features and benefits

FEATURES	BENEFITS
<ul style="list-style-type: none"> ◇ tackable, load-bearing frames 	<ul style="list-style-type: none"> ◇ Flexibility to reconfigure as privacy requirements change, lowering the cost of ownership and reducing inventory levels ◇ Accommodates mounted storage
<ul style="list-style-type: none"> ◇ Tiles are offered in a variety of fabrics and finishes 	<ul style="list-style-type: none"> ◇ Complements existing furniture or infrastructure ◇ Finish offering allows for easy customization or personalization of an environment
<ul style="list-style-type: none"> ◇ The belt-line hinged electrical access door easily opens with one hand and stays open while access is required 	<ul style="list-style-type: none"> ◇ Discreetly conceals electrical and data cables at the belt-line ◇ Provides comfortable access to power and data for the user
<ul style="list-style-type: none"> ◇ Complemented by a selection of accessories including whiteboards, keyboard drawers, task lighting, paper trays, pencil holders, etc. 	<ul style="list-style-type: none"> ◇ Enhances the functionality of a workspace in a multi-task environment ◇ Facilitates paper management in a workstation
<ul style="list-style-type: none"> ◇ Durable laminate worksurfaces in a variety of shapes and colors ◇ 1-inch or 1.5-inch thickness option 	<ul style="list-style-type: none"> ◇ Increases space planning possibilities ◇ Adds distinction to private offices
<ul style="list-style-type: none"> ◇ A variety of acrylic options for tiles 	<ul style="list-style-type: none"> ◇ Elevates the overall aesthetic of the system ◇ Controls the degree of privacy required in a workspace ◇ Allows access to natural light throughout the office, resulting in greater productivity
<ul style="list-style-type: none"> ◇ Metal trim and top caps 	<ul style="list-style-type: none"> ◇ Aesthetically more attractive and environmentally friendly than plastic trim
<ul style="list-style-type: none"> ◇ Tiles are mounted to the frame independently of one another and can be removed without having to remove the tiles above 	<ul style="list-style-type: none"> ◇ Ability to create a dynamic, fully functional workspace capable of addressing multiple workplace needs
<ul style="list-style-type: none"> ◇ Electrics are centrally located at the raceway level 	<ul style="list-style-type: none"> ◇ Easy to change the functionality of panel frames as the needs of the workspace evolves (i.e. increase or decrease visual and acoustical privacy, add a pass-through, tackable or accessory tiles)
<ul style="list-style-type: none"> ◇ Tiles are quality engineered from a superior gauge of steel 	<ul style="list-style-type: none"> ◇ Access to power and data will not be obstructed by items such as storage towers and pedestal
<ul style="list-style-type: none"> ◇ Panels are shipped complete with tiles installed 	<ul style="list-style-type: none"> ◇ Provides maximum strength and durability, which increases the life span of the product, and protects the end user's investment ◇ Increases accuracy and reduces time of installation

variable height panel combinations

Cosmopolitan offers the flexibility of 90, 180, 120, and 135 degree connections at varying heights. Illustrated below are a few connection possibilities for Cosmopolitan panel frames.

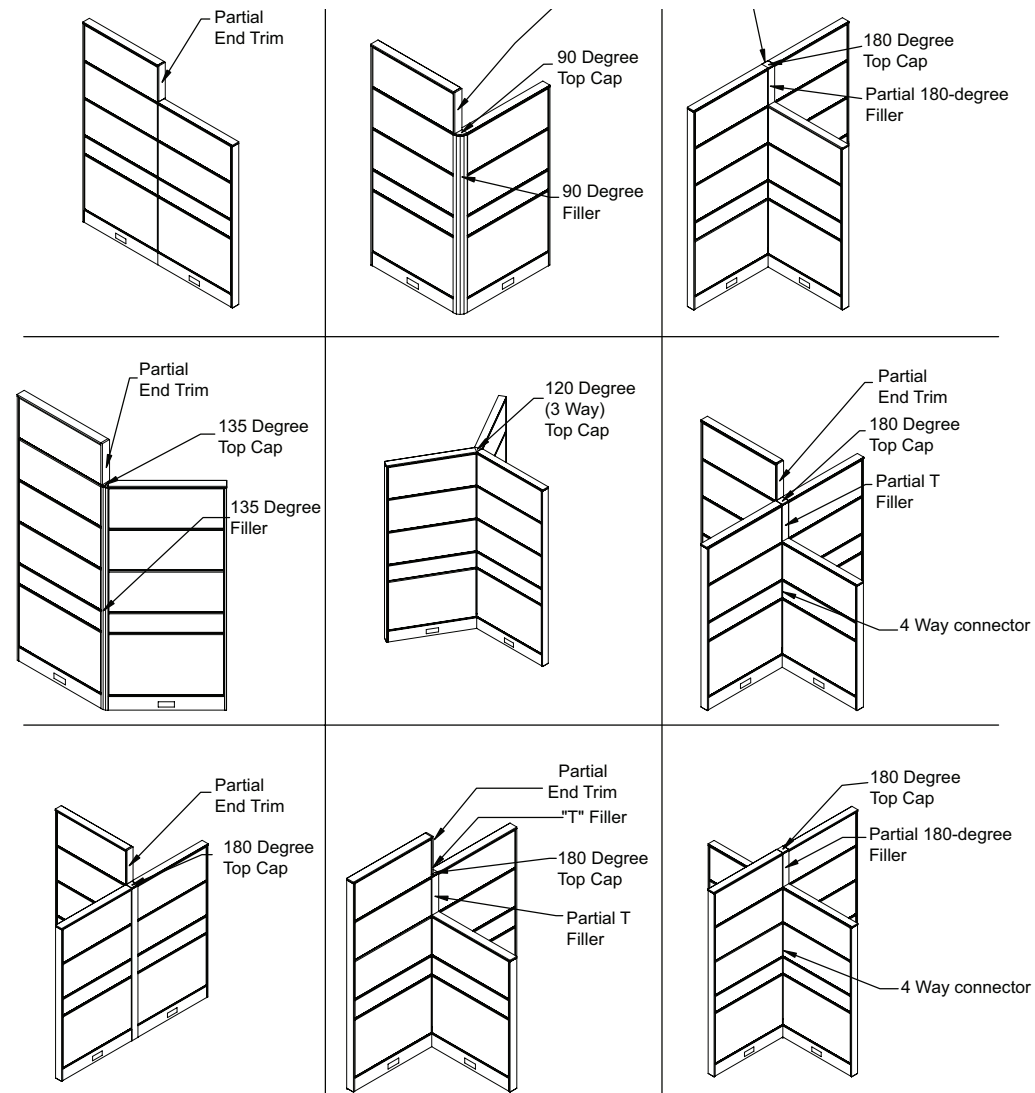

maximum span of panels

When specifying Cosmopolitan, it is important to be mindful of the width that panels are required to span. The following examples illustrate the maximum width that panels can span before they need to be supported by a return panel or wall.

Maximum Span of Panels

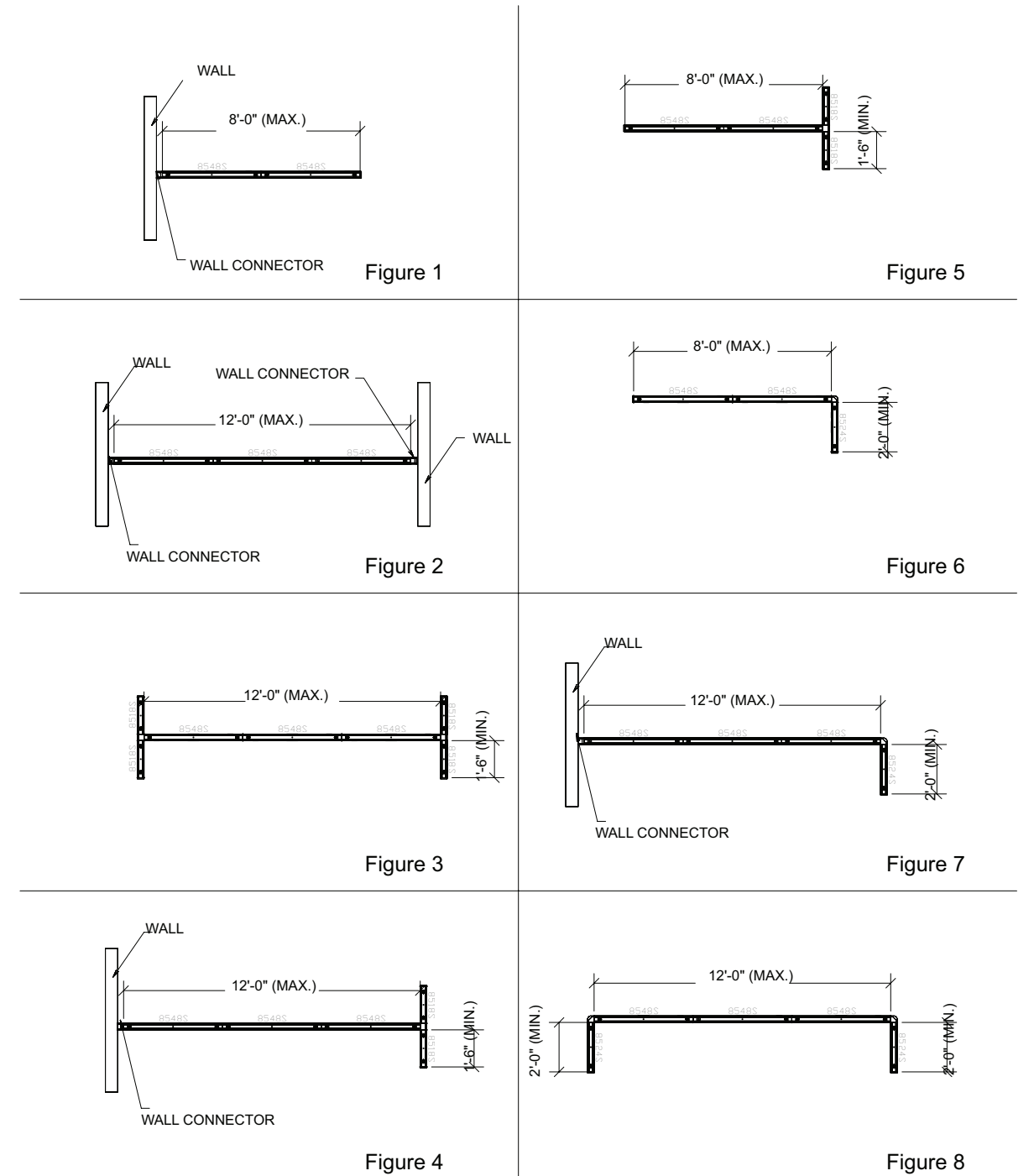

electrical cable length calculation

Use the following diagrams to calculate baseline and belt-line cabling requirements.

electrical cable length calculation on a straight panel connection

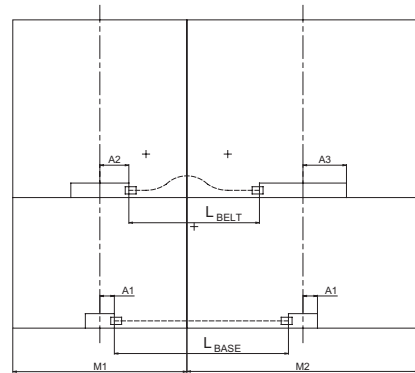

electrical cable length calculation on a corner, T- or X-panel connection

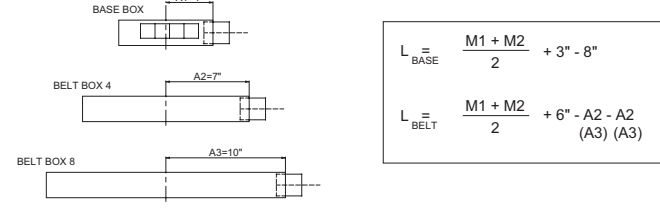
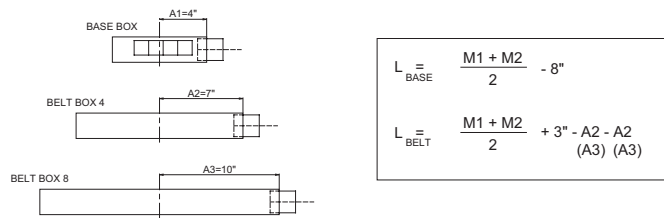
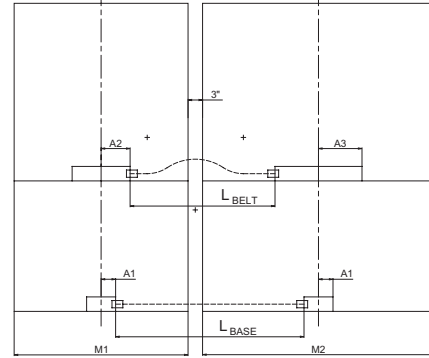

electrical cable length calculation on a straight panel connection

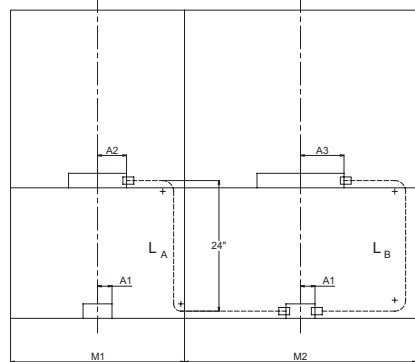

electrical cable length calculation on a corner, T- or X-panel connection

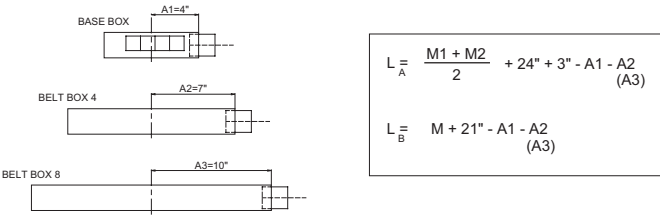
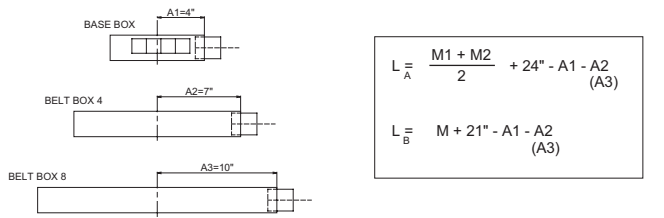
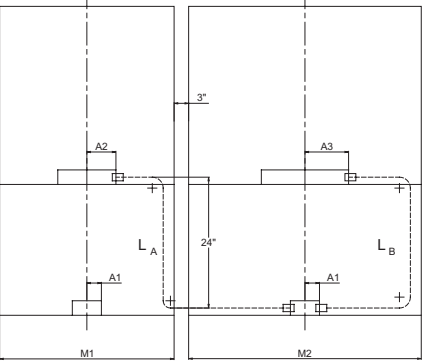

storage capacity and handle options

storage capacities

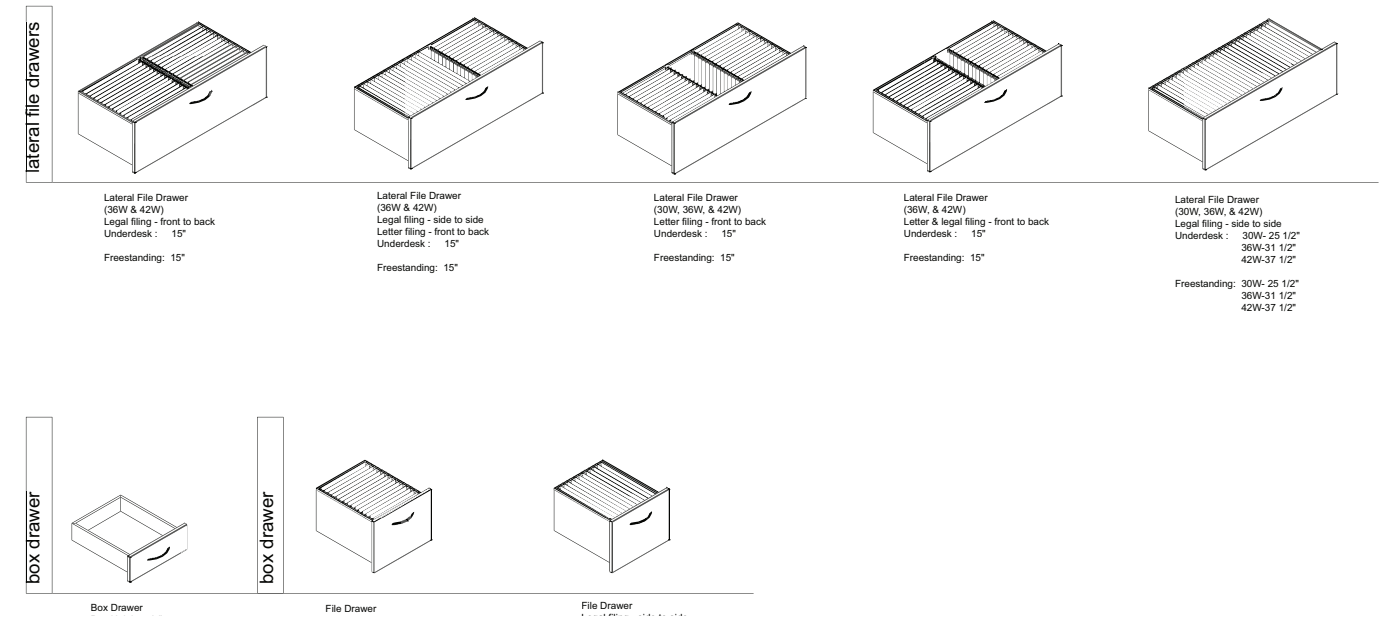

handle options

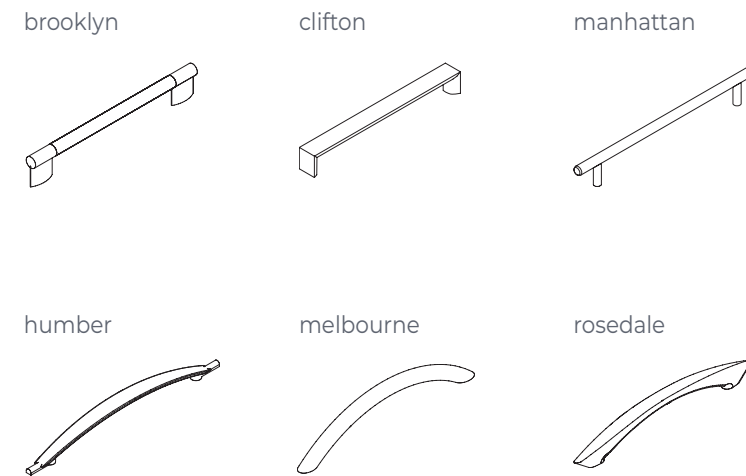

Caution

Load Bottom Drawer First

- ◇ Operate one drawer at a time
- ◇ Units may tip if loaded incorrectly
- ◇ Units should be attached to a wall or other furniture to reduce tipping hazard
- ◇ Always load the heaviest files in the bottom drawer

Heavy Load

- ◇ Some products must be anchored to wall to ensure stability & safety.
- ◇ It is the owner and installers responsibility to ensure that the wall type and construction is of sufficient strength to carry the loads of any wall mounted products and their contents.
- ◇ Failure of the wall and anchors to support all imposed loads may result in property damage and/or personal injury.
- ◇ Tayco can provide size and empty weight of its products only. As wall blocking is considered a building construction process, Tayco cannot provide recommendations in this respect and cannot be responsible for damage or injury that may occur as a result of improper installation and/or blocking.

Instability Hazard

Mobile items on casters such as flip top, personal and movable tables of any type and storage items of any type may present an instability hazard if not secured correctly while in use or in storage. Flip top tables or training tables of any type, are inherently more unstable when folded. Tayco provides the following guidelines & warnings when using mobile products:

- ◇ Lock casters immediately after moving. Do not leave the casters unlocked when in use or in storage.
- ◇ Motion may increase the instability of any item with casters. If the wheels hit an obstruction the table's forward momentum often causes overturn, especially if the item is not equipped with wheel extensions. Exercise strong caution while moving these items.
- ◇ Use caution when abrupt level changes in the floor are present (such as a doorway or room threshold) as caster failure or tipping may result.
- ◇ Do not stand, sit or lean on mobile items for support. They are not intended for this use and personal injury or property damage may result.
- ◇ Mobile units that feature height adjustable elements must be lowered to the minimum compressed height when moving to prevent instability. It is also recommended the user remove all computer equipment or other accessories to prevent possible weight imbalance or damage to equipment.
- ◇ Failure to follow the guidelines above may result in property damage or personal injury.



Cosmo Pricebook
August 2024
Panel Frames

panel frames and connectors

panel frame	18
panel frame for full acrylic panel	20
panel frame with countertop capability	22
panel frame with flip-up capability	24
stack-on panel frame	26
panel door	28
acrylic sliding door	29
lockable acrylic sliding door	30
end trim	31
wall-to-panel connector	32
t-connection filler	34
90-degree filler	35
180-degree connection filler	36
135-degree 2-way connector	37
120-degree 2-way connection filler	38
120-degree 3-way connection filler	40
4-way connection filler	41
floor grippers	42

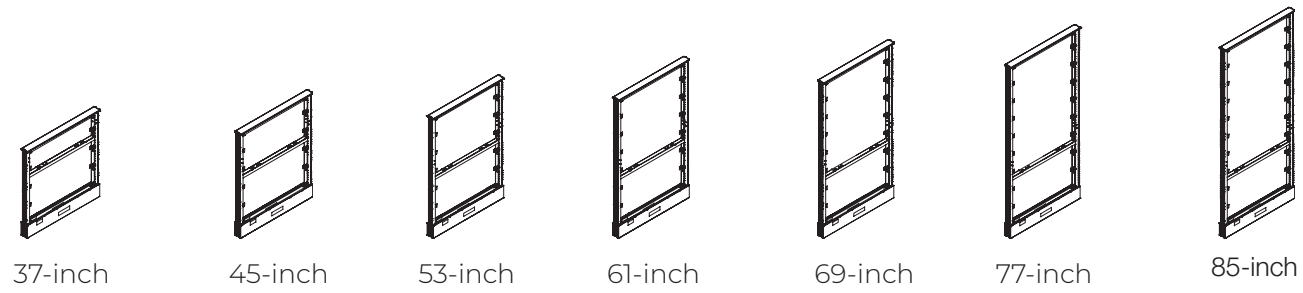

What's Included:

Panel frame, metal base raceway, metal to metal connection hardware

How to Specify:

Specify panel trim finish.

The color of the raceway defaults to the color of the top trim when a metal color is specified.

Notes:

Any Cosmo stack-on frame of the same width can be stacked on top of this panel frame.

An 8 wire, 4 circuit electrical system is available for the base-line or belt-line. 37-inch panel frames do not accommodate a flip-up belt-line tile. Specify the panel frame with flip-up capability [page 26](#) when this function is required.

Power and communications November be run into the panel frame using either a power pole or an electrical harness. See the electric, communication, and lighting section for details.

The metal frame is only available in black.

Options:

height	37, 45, 53, 61, 69, 77, 85
width	18, 24, 30, 36, 42, 48, 54, 60
top cap finish	metal colors
panel trim	style
power	8 wire 4 circuit electrical system (to be specified separately)

Code	Price	H (in.)	W (in.)	Weight (lb.)	Volume (ft ³)	Code	Price	H (in.)	W (in.)	Weight (lb.)	Volume (ft ³)
C-PF00-3718	307	37	18	14.6	1.2	C-PF00-6142	489	61	42	27.8	4.7
C-PF00-3724	342	37	24	16.5	1.7	C-PF00-6148	520	61	48	29.8	5.4
C-PF00-3730	371	37	30	18.5	2.1	C-PF00-6154	548	61	54	31.8	6
C-PF00-3736	405	37	36	20.5	2.4	C-PF00-6160	579	61	60	33.7	6.7
C-PF00-3742	435	37	42	22.4	2.9	C-PF00-6918	382	69	18	21.8	2.3
C-PF00-3748	461	37	48	24.4	3.3	C-PF00-6924	414	69	24	23.7	3
C-PF00-3754	496	37	54	26.4	3.7	C-PF00-6930	443	69	30	25.7	3.8
C-PF00-3760	526	37	60	28.3	4.1	C-PF00-6936	474	69	36	27.7	4.5
C-PF00-4518	328	45	18	16.4	1.5	C-PF00-6942	504	69	42	29.6	5.3
C-PF00-4524	360	45	24	18.3	2	C-PF00-6948	534	69	48	31.6	6.1
C-PF00-4530	387	45	30	20.3	2.5	C-PF00-6954	566	69	54	33.6	6.8
C-PF00-4536	421	45	36	22.3	3	C-PF00-6960	597	69	60	35.5	7.6
C-PF00-4542	452	45	42	24.2	3.5	C-PF00-7718	398	77	18	23.6	2.5
C-PF00-4548	479	45	48	26.2	4	C-PF00-7724	428	77	24	25.5	3.4
C-PF00-4554	511	45	54	28.2	4.5	C-PF00-7730	458	77	30	27.5	4.2
C-PF00-4560	541	45	60	30.1	5	C-PF00-7736	491	77	36	29.5	5.1
C-PF00-5318	345	53	18	18.2	1.8	C-PF00-7742	522	77	42	31.4	5.9
C-PF00-5324	375	53	24	20.1	2.3	C-PF00-7748	550	77	48	33.4	6.7
C-PF00-5330	407	53	30	22.1	2.9	C-PF00-7754	580	77	54	35.5	7.6
C-PF00-5336	438	53	36	24.1	3.5	C-PF00-7760	614	77	60	37.3	8.4
C-PF00-5342	469	53	42	26	4.1	C-PF00-8518	414	85	18	25.4	2.8
C-PF00-5348	498	53	48	28	4.7	C-PF00-8524	445	85	24	27.3	3.7
C-PF00-5354	528	53	54	30	5.3	C-PF00-8530	475	85	30	29.3	4.6
C-PF00-5360	562	53	60	31.9	5.19	C-PF00-8536	505	85	36	31.3	5.6
C-PF00-6118	364	61	18	20	2	C-PF00-8542	536	85	42	33.2	6.5
C-PF00-6124	398	61	24	21.9	2.7	C-PF00-8548	567	85	48	35.2	7.4
C-PF00-6130	426	61	30	23.9	3.4	C-PF00-8554	598	85	54	37.2	8.3
C-PF00-6136	457	61	36	25.9	4	C-PF00-8560	630	85	60	39.1	9.3

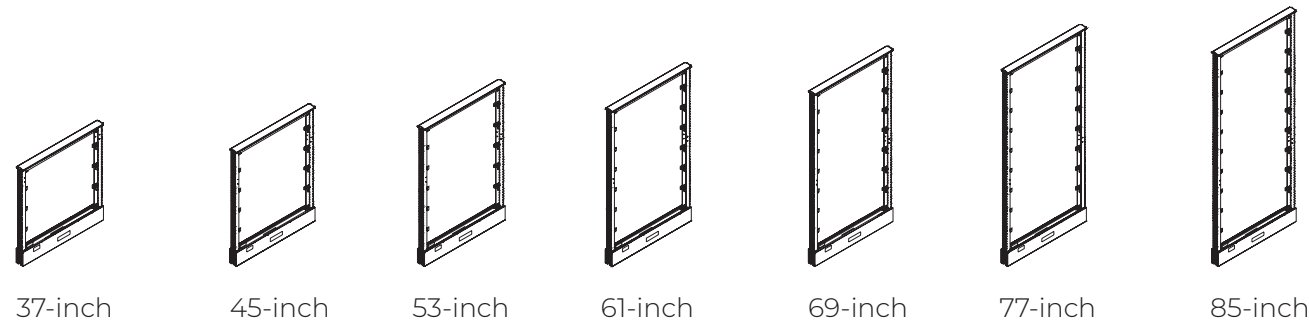

What's Included:

Panel frame for acrylic panel, metal base raceway, metal to metal connection hardware.

How to Specify:

Specify panel trim finish.

The color of the raceway defaults to the color of the top trim when a metal color is specified.

Notes:

An 8 wire, 4 circuit electrical system is available at the base-line.

Power and communications November be run into the panel frame using either a power pole or an electrical harness. See the electric, communication, and lighting section for details.

The metal frame is only available in black.

Options:

height	37, 45, 53, 61, 69, 77, 85
width	18, 24, 30, 36, 42, 48, 54, 60
top cap finish	metal colors
panel trim	style
power	8 wire 4 circuit electrical system (to be specified separately)

Code	Price	H (in.)	W (in.)	Weight (lb.)	Volume (ft ³)	Code	Price	H (in.)	W (in.)	Weight (lb.)	Volume (ft ³)
C-PFG0-3718	305	37	18	14.6	1.2	C-PFG0-6142	478	61	42	27.8	4.7
C-PFG0-3724	336	37	24	16.5	1.7	C-PFG0-6148	505	61	48	29.8	5.4
C-PFG0-3730	364	37	30	18.5	2.1	C-PFG0-6154	536	61	54	31.8	6
C-PFG0-3736	396	37	30	20.5	2.4	C-PFG0-6160	566	61	60	33.7	6.7
C-PFG0-3742	423	37	42	22.4	2.9	C-PFG0-6918	379	69	18	21.8	2.3
C-PFG0-3748	453	37	48	24.4	3.3	C-PFG0-6924	408	69	24	23.7	3
C-PFG0-3754	479	37	54	26.4	3.7	C-PFG0-6930	438	69	30	25.7	3.8
C-PFG0-3760	511	37	60	28.3	4.1	C-PFG0-6936	466	69	36	27.7	4.5
C-PFG0-4518	324	45	18	16.4	1.5	C-PFG0-6942	497	69	42	29.6	5.3
C-PFG0-4524	354	45	24	18.3	2	C-PFG0-6948	523	69	48	31.6	6.1
C-PFG0-4530	383	45	30	20.3	2.5	C-PFG0-6954	552	69	54	33.6	6.8
C-PFG0-4536	412	45	36	22.3	3	C-PFG0-6960	580	69	60	35.5	7.6
C-PFG0-4542	440	45	42	24.2	3.5	C-PFG0-7718	395	77	18	23.6	2.5
C-PFG0-4548	470	45	48	26.2	4	C-PFG0-7724	423	77	24	25.5	3.4
C-PFG0-4554	500	45	54	28.2	4.5	C-PFG0-7730	453	77	30	27.5	4.2
C-PFG0-4560	528	45	60	30.1	5	C-PFG0-7736	484	77	36	29.5	5.1
C-PFG0-5318	340	53	18	18.2	1.8	C-PFG0-7742	511	77	42	31.4	5.9
C-PFG0-5324	370	53	24	20.1	2.3	C-PFG0-7748	540	77	48	33.4	6.7
C-PFG0-5330	400	53	30	22.1	2.9	C-PFG0-7754	568	77	54	35.5	7.6
C-PFG0-5336	428	53	36	24.1	3.5	C-PFG0-7760	601	77	60	37.3	8.4
C-PFG0-5342	457	53	42	26	4.1	C-PFG0-8518	409	85	18	25.4	2.8
C-PFG0-5348	488	53	48	28	4.7	C-PFG0-8524	440	85	24	27.3	3.7
C-PFG0-5354	513	53	54	30	5.3	C-PFG0-8530	470	85	30	29.3	4.6
C-PFG0-5360	546	53	60	31.9	5.9	C-PFG0-8536	500	85	36	31.3	5.6
C-PFG0-6118	361	61	18	20	2	C-PFG0-8542	528	85	42	33.2	6.5
C-PFG0-6124	389	61	24	21.9	2.7	C-PFG0-8548	559	85	48	35.2	7.4
C-PFG0-6130	421	61	30	23.9	3.4	C-PFG0-8554	582	85	54	37.2	8.3
C-PFG0-6136	451	61	36	25.9	4	C-PFG0-8560	617	85	60	39.1	9.3

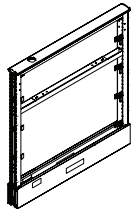

Capability: single panel

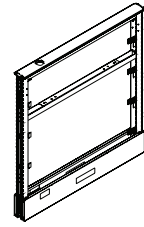

Capability: 1 hole

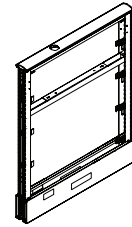

Capability: 54-inch countertop

What's Included:

Panel frame with countertop capability, metal base raceway, metal to metal connection hardware.

How to Specify:

Specify panel trim finish.

Specify this item when a 37-inch high or 45-inch high panel with countertop capabilities is required, but an electrical access door is not needed.

When a 54-inch countertop is supported by a 30-inch wide panel and a 24-inch wide panel, the hole in the 30-inch panel will be located 6 inches away from the end of the panel. When two 30-inch wide panels are used to support a 54-inch wide countertop, the holes will be located 9 inches away from the end of the panel. A 60-inch panel has two holes located 9 inches away from the ends of the panel to accommodate 54-inch wide countertops.

The color of the raceway defaults to the color of the top trim when a metal color is specified.

Notes:

An 8 wire, 4 circuit electrical system is available at the base-line. For belt-line, specify the panel frame with flip-up capabilities [page 26](#).

Power and communications November be run into the panel frame using either a power pole or an electrical harness. See the electrics, communication, and lighting section for details.

2 holes are used when a single panel frame is supporting a countertop of the same width.

1 hole, 6 inches away from the end of the panel frame is used when two panels are supporting a countertop equal to the sum of their widths.

1 hole, 9 inches away from the end of the panel frame is used when two 30-inch wide panels are supporting a 54-inch countertop.

The metal frame is only available in black.

Options:

height	37, 45
width	18, 24, 30, 36, 42, 48, 54, 60
top cap finish	metal colors

Code	Price	H (in.)	W (in.)	Weight (lb.)	Volume (ft ³)
37-inches High With Countertop Capability					
C-PF00-3724-C	354	37	24	17.6	1.7
C-PF00-3730-C	385	37	30	19.9	2.1
C-PF00-3736-C	418	37	36	22.2	2.5
C-PF00-3742-C	449	37	42	24.4	2.9
C-PF00-3748-C	477	37	48	26.7	3.31
C-PF00-3754-C	509	37	54	29	3.7
C-PF00-3760-C	537	37	60	31.3	4.1
37-inches High With Countertop Capability, Side-By-Side Panels					
C-PF00-3718-1	324	37	18	15.4	1.2
C-PF00-3724-1	354	37	24	17.6	1.7
C-PF00-3730-1	385	37	30	19.9	2.1
37-inches High With 54-inch High Countertop Capability, Side-By-Side Panels					
C-PF00-3730-1-P	385	37	30	19.9	2.1
45-inches High With Countertop Capability					
C-PF00-4524-C	370	45	24	17.6	1.7
C-PF00-4530-C	401	45	30	19.9	2.1
C-PF00-4536-C	431	45	36	22.2	2.5
C-PF00-4542-C	461	45	42	24.4	2.9
C-PF00-4548-C	492	45	48	26.7	3.3
C-PF00-4554-C	523	45	54	29	3.7
C-PF00-4560-C	557	45	60	31.3	4.1
45-inches High With Countertop Capability, Side-By-Side Panels					
C-PF00-4518-1	337	45	18	15.37	1.5
C-PF00-4524-1	370	45	24	17.6	2
C-PF00-4530-1	401	45	30	19.9	2.1
45-inches With 54-inch Countertop Capability, Side-By-Side Panels					
C-PF00-4530-1-P	401	45	30	19.88	2.5

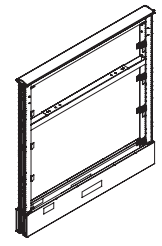

Capability:
without countertop

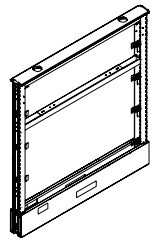

Capability:
single panel

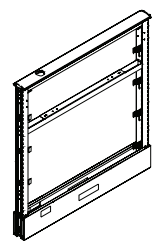

Capability:
1 hole

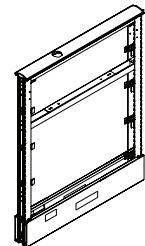

Capability:
54-inch countertop

What's Included:

Panel frame with flip-up capability, metal base raceway, metal to metal connection hardware.

How to Specify:

Specify panel trim finish.

Specify this product when a 37-inch high panel frame with a flip-up belt line is required.

When a countertop is supported by a single panel (C), the holes will be located six inches away from the end of the panel.

When a 54-inch countertop is supported by a 30-inch wide panel and a 24-inch wide panel, the holes in the 30-inch panel will be located 6 inches away from the end of the panel. When two 30-inch wide panels are used to support a 54-inch wide countertop, the holes will be located 9 inches away from the end of the panel. A 60-inch panel has 2 holes located 9 inches away from the ends of the panel to accommodate 54-inch wide countertops.

The color of the raceway defaults to the color of the top trim when a metal color is specified.

Notes:

An 8 wire, 4 circuit electrical system is available for the base-line or belt-line.

Power and communications November be run into the panel frame using either a power pole or an electrical harness. See the electrics, communication, and lighting section [page 188](#) for details.

2 holes are used when a single panel frame is supporting a countertop of the same width.

1 hole, 6 inches away from the end of the panel frame is used when two panels are supporting a countertop equal to the sum of their widths.

1 hole, 9 inches away from the end of the panel frame is used when two 30-inch wide panels are supporting a 54-inch countertop.

The metal frame is only available in black.

Options:

height	37
width	18, 24, 30, 36, 42, 48, 54, 60
countertop capability	without countertop with countertop
top cap finish	metal colors
raceway finish	metal colors

Code	Price	H (in.)	W (in.)	Weight (lb.)	Volume (ft ³)
37-inches High With Flip-Up					
C-PF0F-3718	324	37	18	14.6	1.2
C-PF0F-3724	354	37	24	16.5	1.7
C-PF0F-3730	385	37	30	18.5	2.1
C-PF0F-3736	418	37	36	20.5	2.4
C-PF0F-3742	449	37	42	22.4	2.9
C-PF0F-3748	477	37	48	24.4	3.3
C-PF0F-3754	509	37	54	26.4	3.7
C-PF0F-3760	537	37	60	28.3	4.1
37-inches High With Countertop Capability, Single Panel, Flip-Up					
C-PF0F-3724-C	354	37	24	17.6	1.7
C-PF0F-3730-C	385	37	30	19.9	2.1
C-PF0F-3736-C	418	37	36	22.2	2.5
C-PF0F-3742-C	449	37	42	24.4	2.9
C-PF0F-3748-C	477	37	48	26.7	3.3
C-PF0F-3754-C	509	37	54	29	3.7
C-PF0F-3760-C	537	37	60	31.3	4.1
37-inches High with Countertop Capability, Side-By-Side Panels, Flip-Up					
C-PF0F-3718-1	324	37	18	15.4	1.2
C-PF0F-3724-1	354	37	24	17.6	1.7
C-PF0F-3730-1	385	37	30	19.9	2.1
37-inches High With 54-inch Countertop Capability, Side-By-Side Panels, Flip-Up					
C-PF0F-3730-1-P	385	37	30	19.9	2.1

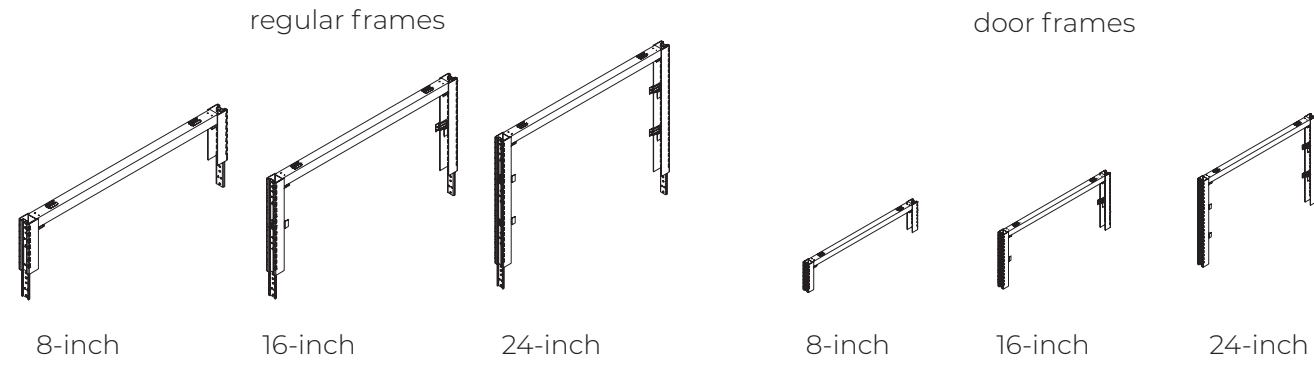

What's Included:

Stack-on panel frame, metal to metal connection hardware.

Notes:

Metal frame is only available in black.

Top trim is not included. Install the top trim from the panel below.

Regular stack-on panel frame can be installed on any panel frame of the same width. Swing Door stack-on panel frame can be installed on a door of the same width between two other stackable frames or between a stackable panel frame and a panel filler.

Options:

frame type	0 regular frames 1 door frames
height	8, 16, 24
width	18, 24, 30, 36, 42, 48, 54, 60

Code	Price	H (in.)	W (in.)	Weight (lb.)	Volume (ft ³)
Regular Frame					
C-PS00-0818	111	8	18	4.4	0.3
C-PS00-0824	116	8	24	5	0.3
C-PS00-0830	124	8	30	5.7	0.4
C-PS00-0836	131	8	36	6.3	0.5
C-PS00-0842	139	8	42	6.9	0.6
C-PS00-0848	151	8	48	7.6	0.7
C-PS00-0854	155	8	54	8.2	0.8
C-PS00-0860	165	8	60	8.9	0.9
C-PS00-1618	126	16	18	6.2	0.5
C-PS00-1624	131	16	24	6.8	0.7
C-PS00-1630	139	16	30	7.5	0.9
C-PS00-1636	151	16	36	8.1	1
C-PS00-1642	155	16	42	8.7	1.2
C-PS00-1648	165	16	48	9.4	1.4
C-PS00-1654	171	16	54	10	1.5
C-PS00-1660	179	16	60	10.7	1.7
C-PS00-2418	138	24	18	8	0.8
C-PS00-2424	148	24	24	8.6	1
C-PS00-2430	153	24	30	9.3	1.3
C-PS00-2436	161	24	36	9.9	1.5
C-PS00-2442	167	24	42	10.5	1.8
C-PS00-2448	175	24	48	11.2	2.1
C-PS00-2454	184	24	54	11.8	2.3
C-PS00-2460	191	24	60	12.5	2.6
Door Frame					
C-PS01-0836	123	8	36	6.3	0.5
C-PS01-0842	128	8	42	6.9	0.6
C-PS01-1636	138	16	36	8.1	1
C-PS01-1642	149	16	42	8.7	1.2
C-PS01-2436	152	24	36	9.9	1.5
C-PS01-2442	156	24	42	10.5	1.8

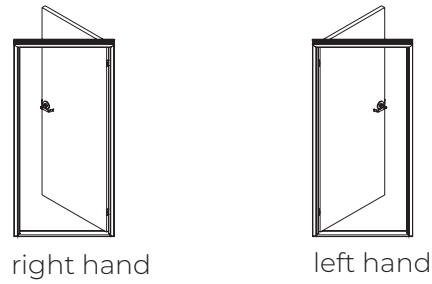

What's Included:

Panel door, door frame, lever type handle, connection hardware.

How to Specify:

Specify panel trim finish.

The panel trim finish must be specified. The door and door frame are available in all paint colors and will match the color of the top trim.

Right or left hand must be specified.

Specify laminate

Notes:

Door is powder painted MDF.

The door must be connected to 85-inch high panel frames or panel fillers.

Options:

width	36, 42		
hand	R right	L left	
laminate	L167 black	L121 white	L112 silver
door & door frame finish	metal colors		
top cap finish	metal colors		

How to Order and Read your Code:

C **PD00** **85** **36** **R or L**
 product line item height width hand

Code	Price	H (in.)	W (in.)	Weight (lb.)	Volume (ft ³)
C-PD00-8536-L	3407	85	36	68	5.6
C-PD00-8542-L	3710	85	42	80	6.5
C-PD00-8536-R	3407	85	36	68	5.6
C-PD00-8542-R	3710	85	42	80	6.5

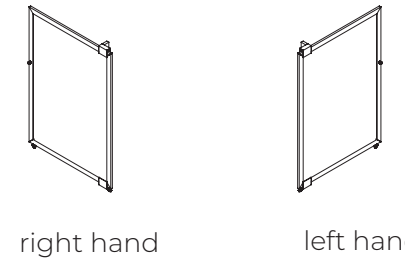

What's Included:

Acrylic sliding door, metal to metal connection hardware.

How to Specify:

Specify panel trim finish.

A metal color must be specified for the panel trim.

Right or left hand must be specified.

The acrylic option must be specified. When frosted or clear acrylic is specified, an upcharge is applicable.

Notes:

The sliding door height must be connected to a panel of equal height.

The acrylic sliding door provides visual privacy for individual stations.

Sliding doors must always be connected to a panel.

Options:

height	61, 69		
width	30, 36, 42		
hand	R right L left		
acrylic option	Fluted	Frosted*	Clear*
frame finish	metal colors		

How to Order and Read your Code:

C **PDSG** **61** **30** **R or L**
 product line item height width hand

Code	Price	H (in.)	W (in.)	Weight (lb.)	Volume (ft ³)
C-PDSG-6130-L	2230	61	30	53	4
C-PDSG-6136-L	2313	61	36	53	4
C-PDSG-6142-L	2400	61	42	53	4.6
C-PDSG-6930-L	2333	69	30	53	4
C-PDSG-6936-L	2421	69	36	53	4.5
C-PDSG-6942-L	2502	69	42	53	5.2
*clear & frosted acrylic upcharge	581				

Code	Price	H (in.)	W (in.)	Weight (lb.)	Volume (ft ³)
C-PDSG-6130-R	2230	61	30	53	4
C-PDSG-6136-R	2313	61	36	53	4
C-PDSG-6142-R	2400	61	42	53	4.6
C-PDSG-6930-R	2333	69	30	53	4
C-PDSG-6936-R	2421	69	36	53	4.5
C-PDSG-6942-R	2502	69	42	53	5.2
*clear & frosted acrylic upcharge	581				

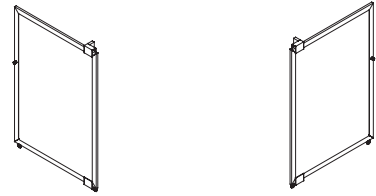

right hand left hand

What's Included:

Acrylic sliding door, metal to metal connection hardware.

How to Specify:

Specify panel trim finish.

A metal color must be specified for the panel trim.

Right or left hand must be specified.

The acrylic option must be specified. When frosted or clear acrylic is specified, an upcharge is applicable.

Notes:

The sliding door height must be connected to a panel of equal height.

The lockable acrylic sliding door provides visual privacy for individual stations.

Sliding doors must always be connected to a panel.

Options:

height	61, 69		
width	30, 36, 42		
lock	LK		
hand	R right L left		
acrylic option	Fluted	Frosted*	Clear*
frame finish	metal colors		

How to Order and Read your Code:

C **PDSG** **61** **30** **LK** **R or L**
 product line item height width lock hand

Code	Price	H (in.)	W (in.)	Weight (lb.)	Volume (ft ³)
C-PDSG-6130-LK-L	2574	61	30	53	4
C-PDSG-6136-LK-L	2657	61	36	53	4
C-PDSG-6142-LK-L	2739	61	42	53	4.6
C-PDSG-6930-LK-L	2679	69	30	53	4
C-PDSG-6936-LK-L	2761	69	36	53	4.5
C-PDSG-6942-LK-L	2844	69	42	53	5.2

Code	Price	H (in.)	W (in.)	Weight (lb.)	Volume (ft ³)
C-PDSG-6130-LK-R	2574	61	30	53	4
C-PDSG-6136-LK-R	2657	61	36	53	4
C-PDSG-6142-LK-R	2739	61	42	53	4.6
C-PDSG-6930-LK-R	2679	69	30	53	4
C-PDSG-6936-LK-R	2761	69	36	53	4.5
C-PDSG-6942-LK-R	2844	69	42	53	5.2

* clear & frosted acrylic upcharge 581

**clear & frosted acrylic upcharge 581

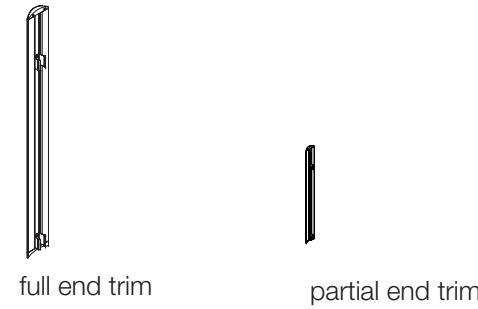

full end trim partial end trim

What's Included:

Full End Trim: full end trim, connection hardware.

Partial End Trim: partial end trim, connection hardware, bottom plastic connector trim.

How to Specify:

Specify panel trim finish.

A metal color must be specified.

Notes:

Use the full end trim to finish a panel at the end of a run.

Use the partial end trim to finish a panel where a change of height occurs

Options:

height	8, 16, 24, 32, 37, 40, 45, 48, 53, 56, 61, 64, 69, 72, 77, 85, 93, 101, 109		
type	O full end trim	P partial end trim	
end trim finish	metal colors		

Code	Price	H (in.)	Weight (lb)	Volume (ft ³)
Full End Trim				
C-HET0-37	84	37	2.2	0.1
C-HET0-45	94	45	2.4	0.1
C-HET0-53	107	53	2.6	0.1
C-HET0-61	116	61	2.8	0.1
C-HET0-69	127	69	3	0.1
C-HET0-77	138	77	3.2	0.1
C-HET0-85	151	85	3.4	0.1
C-HET0-93	158	93	3.6	0.1
C-HET0-101	170	101	3.8	0.1
C-HET0-109	179	109	4	0.1

Code	Price	H (in.)	Weight (lb)	Volume (ft ³)
Partial End Trim				
C-HETP-08	47	8	1.2	0.1
C-HETP-16	56	16	1.6	0.1
C-HETP-24	67	24	2	0.1
C-HETP-32	80	32	2.4	0.1
C-HETP-40	90	40	2.8	0.1
C-HETP-48	101	48	3.2	0.1
C-HETP-56	112	56	3.4	0.1
C-HETP-64	123	64	3.6	0.1

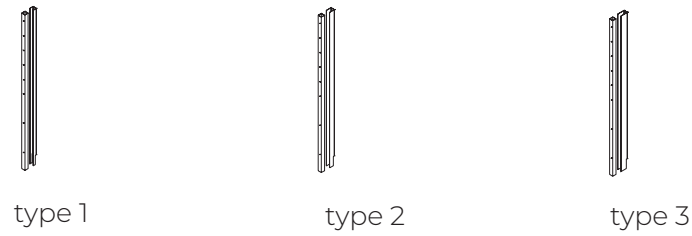

What's Included:

Wall-to-Panel Connector (Type 1, 2 or 3, as specified), top cap, connection hardware for drywall applications.

How to Specify:

Specify panel trim finish.

A metal color must be specified for the top cap finish.

The wall-to-panel connector finish color defaults to match the top cap.

Notes:

Wall-to-panel connectors fill in the gap between the wall and the panel.

Type 1 connectors allow for an adjustment range of 2.25 to 3.25 inches

Type 2 connectors allow for an adjustment range of 3 to 4.25 inches.

Type 3 connectors allow for an adjustment range of 4 to 5.25 inches.

The top cap is 66-inches and must be cut to the proper size on-site.

Options:

type	1 - type 1	2 - type 2	3 - type 3
height	29, 37, 45, 53, 61, 69, 77, 85, 93, 101, 109		
top cap finish	metal colors		
panel trim	style		

Code	Price	H (in.)	Weight (lb.)	Volume (ft ³)
Type 1 (2.25 to 3.25-inches)				
C-HWA1-29	396	29	3.6	0.2
C-HWA1-37	277	37	1.1	0.2
C-HWA1-45	294	45	1.3	0.3
C-HWA1-53	311	53	1.5	0.3
C-HWA1-61	345	61	1.7	0.4
C-HWA1-69	361	69	1.9	0.4
C-HWA1-77	382	77	2.1	0.5
C-HWA1-85	403	85	2.3	0.5
C-HWA1-93	430	93	2.5	0.6
C-HWA1-101	451	101	2.7	0.6
Type 2 (3.00 to 4.25-inches)				
C-HWA2-29	412	29	4.2	0.34
C-HWA2-37	281	37	1.1	0.4
C-HWA2-45	299	45	1.3	0.4
C-HWA2-53	322	53	1.5	0.5
C-HWA2-61	353	61	1.7	0.6
C-HWA2-69	371	69	1.9	0.7
C-HWA2-77	395	77	2.1	0.7
C-HWA2-85	418	85	2.3	0.8
C-HWA2-93	445	93	2.5	0.9
C-HWA2-101	466	101	2.7	1
Type 3 (4.00 to 5.25-inches)				
C-HWA3-29	449	29	5.8	0.47
C-HWA3-37	286	37	1.1	0.4
C-HWA3-45	305	45	1.3	0.4
C-HWA3-53	328	53	1.5	0.5
C-HWA3-61	361	61	1.7	0.6
C-HWA3-69	383	69	1.9	0.7
C-HWA3-77	405	77	2.1	0.7
C-HWA3-85	428	85	2.3	0.8
C-HWA3-93	457	93	2.5	0.9
C-HWA3-101	478	101	2.7	1



full T-connection filler



partial T-connection filler

What's Included:

Full Filler: full t-connection filler, top cap, connection hardware.

Partial Filler: partial t-connection filler, top cap, bottom plastic connector trim, connection hardware

How to Specify:

Specify panel trim finish.

A metal color must be specified for the top cap finish.

Notes:

Use the full t-connection filler to connect two panel frames that are the same height.

Use the partial t-connection filler to connect two panel frames where a change of height occurs

Options:

type	R full filler P partial filler
height	8, 16, 24, 29, 32, 37, 40, 45, 48, 53, 56, 61, 64, 69, 72, 77, 85, 93, 101, 109
top cap finish	metal colors
panel trim	style

Code	Price	H (in.)	Weight (lb)	Volume (ft3)
Full T-Connection Filler				
C-HFTR-29	107	29	1.8	0.07
C-HFTR-37	143	37	0.5	0.2
C-HFTR-45	175	45	0.6	0.3
C-HFTR-53	189	53	0.8	0.3
C-HFTR-61	201	61	0.9	0.3
C-HFTR-69	212	69	1	0.4
C-HFTR-77	220	77	1.1	0.4
C-HFTR-85	258	85	1.2	0.5
C-HFTR-93	290	93	1.4	0.5
C-HFTR-101	299	101	1.6	0.6

Code	Price	H (in.)	Weight (lb)	Volume (ft3)
Partial T-Connection Filler				
C-HFTP-08	77	8	0.2	0.1
C-HFTP-16	90	16	0.5	0.1
C-HFTP-24	123	24	0.6	0.1
C-HFTP-32	133	32	0.9	0.2
C-HFTP-40	166	40	1.1	0.2
C-HFTP-48	178	48	1.2	0.3
C-HFTP-56	191	56	1.4	0.3
C-HFTP-64	207	64	1.6	0.4



full 90-degree filler



partial 90-degree filler

What's Included:

Full 90-degree filler: Full 90-degree filler, top cap, connection hardware.

Partial 90-degree filler: Partial 90-degree filler, top cap, bottom plastic connector trim, connection hardware.

How to Specify:

Specify panel trim finish.

A metal color must be specified for the panel trim finish.

Notes:

Use the full 90-degree filler to connect two panel frames that are the same height.

Use the partial 90-degree filler to connect two panel frames where a change of height occurs.

Options:

height	8, 16, 24, 32, 37, 40, 45, 48, 53, 56, 61, 64, 69, 72, 77, 85, 93, 101, 109
type	R full filler P partial filler
top cap finish	metal colors
panel trim	style

Code	Price	H (in.)	Weight (lb)	Volume (ft3)
Full 90-degree Filler				
C-HFNR-37	149	37	1.1	0.2
C-HFNR-45	176	45	1.3	0.3
C-HFNR-53	193	53	1.5	0.3
C-HFNR-61	210	61	1.7	0.3
C-HFNR-69	222	69	1.9	0.4
C-HFNR-77	242	77	2.1	0.4
C-HFNR-85	272	85	2.3	0.5
C-HFNR-93	300	93	2.5	0.5
C-HFNR-101	319	101	2.7	0.6

Code	Price	H (in.)	Weight (lb)	Volume (ft3)
Partial 90-degree Filler				
C-HFNP-08	76	8	0.2	0.1
C-HFNP-16	91	16	0.5	0.1
C-HFNP-24	123	24	0.6	0.1
C-HFNP-32	137	32	0.9	0.2
C-HFNP-40	167	40	1.1	0.2
C-HFNP-48	181	48	1.2	0.3
C-HFNP-56	201	56	1.4	0.3
C-HFNP-64	214	64	1.6	0.4

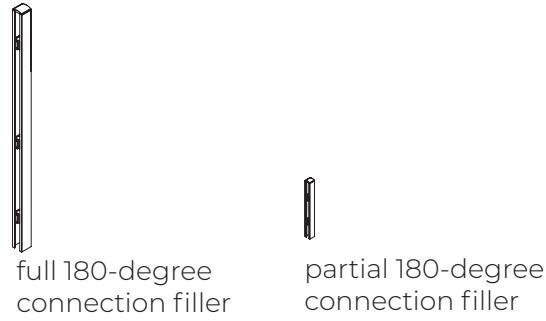

What's Included:

Two 180-degree connection filler covers (full or partial, as specified), top cap, connection hardware.

How to Specify:

Specify panel trim finish.

A metal color must be specified for the panel trim finish.

Notes:

Use the full 180-degree filler to connect two panels that are the same height.

Use the partial 180-degree filler to connect two panel frames where a change of height occurs

Options:

height	8, 16, 24, 32, 37, 40, 45, 48, 53, 56, 61, 64, 69, 72, 77, 85, 93, 101, 109
type	R full filler P partial filler
top cap finish	metal colors
panel trim	style

Code	Price	H (in.)	Weight (lb)	Volume (ft3)
Full 180-degree Filler				
C-HFSR-37	175	175	1.1	0.2
C-HFSR-45	212	212	1.3	0.3
C-HFSR-53	230	230	1.5	0.3
C-HFSR-61	246	246	1.7	0.3
C-HFSR-69	270	270	1.9	0.4
C-HFSR-77	286	286	2.1	0.4
C-HFSR-85	323	323	2.3	0.5
C-HFSR-93	359	359	2.5	0.5
C-HFSR-101	379	379	2.7	0.6

Code	Price	H (in.)	Weight (lb)	Volume (ft3)
Partial 180-degree Filler				
C-HFSP-08	90	90	0.2	0.1
C-HFSP-16	109	109	0.5	0.1
C-HFSP-24	143	143	0.6	0.1
C-HFSP-32	163	163	0.9	0.2
C-HFSP-40	201	201	1.1	0.2
C-HFSP-48	216	216	1.2	0.3
C-HFSP-56	237	237	1.4	0.3
C-HFSP-64	254	254	1.6	0.4



What's Included:

135-degree 2-way connector, top cap, connection hardware.

How to Specify:

Specify panel trim finish.

A metal color must be specified for the top cap finish.

Notes:

Use the 135-degree 2-way connector to connect two panel frames that are the same height.

Options:

height	29, 37, 45, 53, 61, 69, 77, 85, 93, 101, 109
top cap finish	metal colors
panel trim	style

Code	Price	H (in.)	Weight (lb)	Volume (ft3)
C-HF1R-29	81	29	1.8	0.07
C-HF1R-37	117	37	1.1	0.2
C-HF1R-45	143	45	1.3	0.3
C-HF1R-53	153	53	1.5	0.3
C-HF1R-61	163	61	1.7	0.3
C-HF1R-69	171	69	1.9	0.4
C-HF1R-77	179	77	2.1	0.4
C-HF1R-85	208	85	2.3	0.5
C-HF1R-93	231	93	2.5	0.5
C-HF1R-101	241	101	2.7	0.6



full 120-degree 2-way connection filler



partial 120-degree 2-way connection filler

What's Included:

Full Filler: full 120-degree 2-way connection filler, top cap, connection hardware.

Partial Filler: partial 120-degree 2-way connection filler, top cap, bottom plastic connector trim, connection hardware.

How to Specify:

Specify panel trim finish.

A metal color and panel trim style must be specified for the top cap finish.

Options:

height	8, 16, 24, 29, 32, 37, 40, 45, 48, 53, 56, 61, 64, 69, 72, 77, 85, 93, 101, 109	
type	R full filler	P partial filler
top cap finish	metal colors	
panel trim	style	

Notes:

Use the full 120-degree 2-way connection filler to connect two panel frames that are the same height.

Use the partial 120-degree 2-way connection filler to connect two panel frames where a change of height occurs.

Code	Price	H (in.)	Weight (lb)	Volume (ft3)
Full 120-degree 2-way Connection Filler				
C-HF2R-29	100	29	1.8	0.07
C-HF2R-37	124	37	1.1	0.2
C-HF2R-45	152	45	1.3	0.3
C-HF2R-53	158	53	1.5	0.3
C-HF2R-61	170	61	1.7	0.3
C-HF2R-69	179	69	1.9	0.4
C-HF2R-77	191	77	2.1	0.4
C-HF2R-85	216	85	2.3	0.5
C-HF2R-93	243	93	2.5	0.5
C-HF2R-101	252	101	2.7	0.6
Partial 120-degree 2-way Connection Filler				
C-HF2P-80	205	80	1.8	0.07
C-HF2P-08	69	8	0.2	0.1
C-HF2P-16	81	16	0.5	0.1
C-HF2P-24	107	24	0.6	0.1
C-HF2P-32	116	32	0.9	0.2
C-HF2P-40	143	40	1.1	0.2
C-HF2P-48	153	48	1.2	0.3
C-HF2P-56	163	56	1.4	0.3
C-HF2P-64	174	64	1.6	0.4



120-degree 3-way connection filler

What's Included:

120-degree 3-way connection filler, top cap, connection hardware

How to Specify:

Specify panel trim finish.

A metal color and panel trim style must be specified for the top cap finish.

Notes:

Use the 120-degree 3-way connection filler to connect three panel frames that are the same height.

Options:

height 29, 37, 45, 53, 61, 69, 77, 85, 93, 101, 109

top cap finish metal colors

Code	Price	H (in.)	Weight (lb)	Volume (ft3)
C-HF3R-29	86	29	1.8	0.07
C-HF3R-37	86	37	1.1	0.2
C-HF3R-45	107	45	1.3	0.3
C-HF3R-53	112	53	1.5	0.3
C-HF3R-61	114	61	1.7	0.3
C-HF3R-69	117	69	1.9	0.4
C-HF3R-77	123	77	2.1	0.4
C-HF3R-85	141	85	2.3	0.5
C-HF3R-93	161	93	2.5	0.5
C-HF3R-101	166	101	2.7	0.6



4-way connection filler

What's Included:

4-way connection filler, top cap, connection hardware

How to Specify:

Specify panel trim finish.

A metal color and panel trim style must be specified for the top cap finish.

Notes:

Use 4-way connection filler to connect four panel frames that are the same height.

Options:

height 29, 37, 45, 53, 61, 69, 77, 85, 93, 101, 109

top cap finish metal colors

Code	Price	H (in.)	Weight (lb)	Volume (ft3)
C-HF4R-29	86	29	1.8	0.07
C-HF4R-37	113	37	1.1	0.2
C-HF4R-45	143	45	1.3	0.3
C-HF4R-53	151	53	1.5	0.3
C-HF4R-61	154	61	1.7	0.3
C-HF4R-69	158	69	1.9	0.4
C-HF4R-77	163	77	2.1	0.4
C-HF4R-85	194	85	2.3	0.5
C-HF4R-93	222	93	2.5	0.5
C-HF4R-101	231	101	2.7	0.6



carpet floors



non-carpet floors

What's Included:

Floor Gripper (for carpet floors or non-carpet floors, as specified)

How to Specify:

There are no color options for floor grippers.

Notes:

Floor grippers stabilize panels on either carpet floors or non-carpet floors.

Options:

type **C** carpeted floors **N** non-carpeted floors

Code	Price	Weight (lb)	Volume (ft3)
carpeted floors			
C-HGC0	3	0.1	0.01
non carpeted floors			
C-HGN0	3	0.1	0.01



Cosmo Pricebook
August 2024
Tiles

tiles

acoustic tackable fabric tile	46
monolithic fabric tile	50
acrylic tiles	54
magnetic whiteboard tile	57
laminate tile	58
monolithic laminate tile	60
monolithic laminate tile	62
perforated metal tile	66
pass-through tile	68
fabric flip-up belt-line tile	69
accessory tile	70

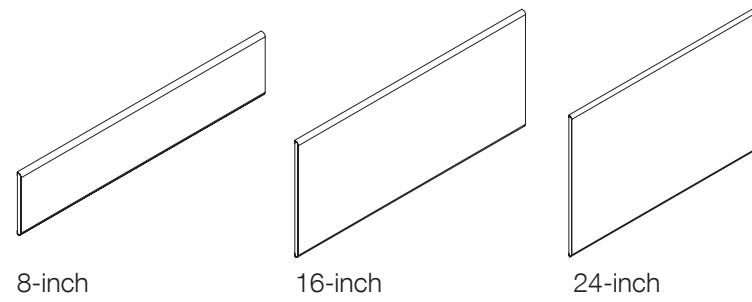

What's Included:

Acoustic Tackable Fabric Tile, installation hardware.

How to Specify:

Refer to the finish card for a complete listing of metal colors.

Notes:

Acoustic tackable fabric tiles provide acoustical privacy and a tackable vertical surface.

Options:

fabric grade	1 - grade 1	2 - grade 2	3 - grade 3
height	8, 16, 24		
width	18, 24, 30, 36, 42, 48, 54, 60		
finish	panel fabrics		

How to Order and Read your Code:

C	PTA	1	8	18
product line	item	fabric grade	height	width

Code	Price	H (in.)	W (in.)	Weight (lb.)	Volume (ft ³)
Grade-1					
C-PTA1-0818	102	8	18	1.9	0.1
C-PTA1-0824	107	8	24	2.4	0.1
C-PTA1-0836	127	8	36	3.7	0.1
C-PTA1-0842	131	8	42	4.2	0.1
C-PTA1-0848	137	8	48	5	0.1
C-PTA1-0860	148	8	60	6.2	0.2
C-PTA1-1624	124	16	24	5	0.1
C-PTA1-1630	128	16	30	6.2	0.2
C-PTA1-1636	153	16	36	7.5	0.2
C-PTA1-1642	158	16	42	8.7	0.2
C-PTA1-1648	165	16	48	10	0.3
C-PTA1-1654	170	16	54	11.2	0.3
C-PTA1-1660	176	16	60	12.5	0.4
C-PTA1-2418	131	24	18	5.6	0.2
C-PTA1-2424	139	24	24	7.3	0.2
C-PTA1-2430	149	24	30	9.3	0.3
C-PTA1-2436	178	24	36	11.2	0.3
C-PTA1-2442	187	24	42	13.1	0.4
C-PTA1-2448	193	24	48	14.9	0.4
C-PTA1-2454	202	24	54	16.8	0.5
C-PTA1-2460	209	24	60	18.7	0.5

Code	Price	H (in.)	W (in.)	Weight (lb.)	Volume (ft ³)
Grade 2					
C-PTA2-0824	111	8	24	2.4	0.1
C-PTA2-0836	133	8	36	3.7	0.1
C-PTA2-0842	139	8	42	4.3	0.1
C-PTA2-0848	143	8	48	5	0.1
C-PTA2-0860	153	8	60	6.2	0.2
C-PTA2-1624	128	16	24	5	0.1
C-PTA2-1630	133	16	30	6.2	0.2
C-PTA2-1636	165	16	36	7.5	0.2
C-PTA2-1642	170	16	42	8.7	0.2
C-PTA2-1648	176	16	48	10	0.3
C-PTA2-1654	181	16	54	11.2	0.3
C-PTA2-1660	189	16	60	12.5	0.4
C-PTA2-2418	139	24	18	5.6	0.2
C-PTA2-2424	149	24	24	7.3	0.2
C-PTA2-2430	154	24	30	9.3	0.3
C-PTA2-2436	194	24	36	11.2	0.3
C-PTA2-2442	205	24	42	13.1	0.4
C-PTA2-2448	210	24	48	14.9	0.4
C-PTA2-2454	216	24	54	16.8	0.5
C-PTA2-2460	220	24	60	18.7	0.5

Code	Price	H (in.)	W (in.)	Weight (lb.)	Volume (ft ³)
Grade 3					
C-PTA3-0824	113	8	24	2.4	0.1
C-PTA3-0836	141	8	36	3.7	0.1
C-PTA3-0842	149	8	42	4.3	0.1
C-PTA3-0848	152	8	48	5	0.1
C-PTA3-0860	158	8	60	6.2	0.2
C-PTA3-1624	133	16	24	5	0.1
C-PTA3-1630	139	16	30	6.2	0.2
C-PTA3-1636	175	16	36	7.5	0.2
C-PTA3-1642	181	16	42	8.7	0.2
C-PTA3-1648	189	16	48	10	0.3
C-PTA3-1654	193	16	54	11.2	0.3
C-PTA3-1660	202	16	60	12.5	0.4
C-PTA3-2418	149	24	18	5.6	0.2
C-PTA3-2424	154	24	24	7.3	0.2
C-PTA3-2430	163	24	30	9.3	0.3
C-PTA3-2436	210	24	36	11.2	0.3
C-PTA3-2442	216	24	42	13.1	0.4
C-PTA3-2448	222	24	48	14.9	0.4
C-PTA3-2454	233	24	54	16.8	0.5
C-PTA3-2460	241	24	60	18.7	0.5

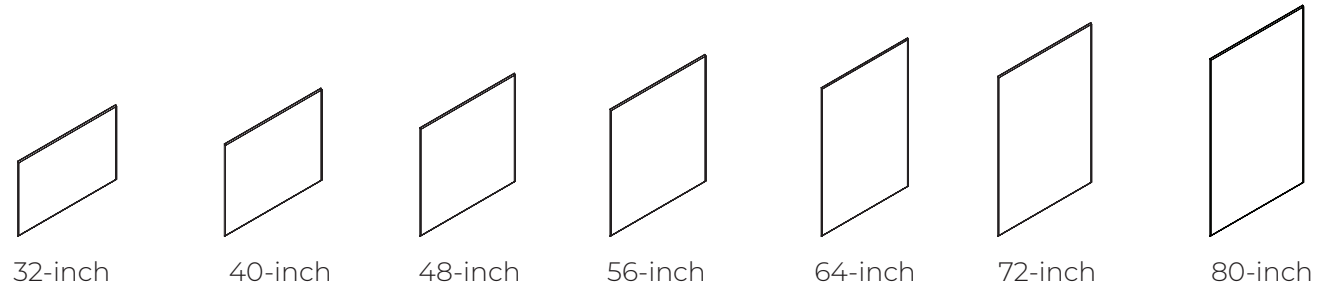

What's Included:

Monolithic fabric tile, installation hardware.

How to Specify:

Refer to the finish card for a complete listing of fabric colors.

Notes:

Monolithic fabric tiles are solid-faced, tackable and offer visual and accoustical privacy.

Monolithic tiles are five inches less than the complete height of the panel frame.

Options:

fabric grade	1 - grade 1	2 - grade 2	3 - grade 3
height	32, 40, 48, 56, 64, 72, 80		
width	18, 24, 30, 36, 42, 48		
finish	panel fabrics		

How to Order and Read your Code:

C	PMA	1	32	18
product line	item	fabric grade	height	width

Code	Price	H (in.)	W (in.)	Weight (lb.)	Volume (ft ³)
Grade 1					
C-PMA1-3218	149	32	18	7	0.3
C-PMA1-3224	155	32	24	8	0.4
C-PMA1-3230	165	32	30	9	0.6
C-PMA1-3236	207	32	36	10	0.7
C-PMA1-3242	213	32	42	11	0.8
C-PMA1-3248	219	32	48	12	0.9
C-PMA1-3254	231	32	54	13	1
C-PMA1-3260	241	32	60	14	1.1
C-PMA1-4018	163	40	18	8	0.4
C-PMA1-4024	171	40	24	9	0.6
C-PMA1-4030	181	40	30	10	0.7
C-PMA1-4036	231	40	36	11	0.8
C-PMA1-4042	242	40	42	12	1
C-PMA1-4048	248	40	48	13	1.1
C-PMA1-4054	261	40	54	14	1.2
C-PMA1-4060	272	40	60	15	1.3
C-PMA1-4818	176	48	18	9	0.5
C-PMA1-4824	190	48	24	10	0.7
C-PMA1-4830	202	48	30	11	0.8
C-PMA1-4836	259	48	36	12	1
C-PMA1-4842	270	48	42	13	1.2
C-PMA1-4848	281	48	48	14	1.3
C-PMA1-4854	293	48	54	15	1.4
C-PMA1-4860	300	48	60	16	1.5
C-PMA1-5618	197	56	18	10	0.6
C-PMA1-5624	212	56	24	11	0.8
C-PMA1-5630	222	56	30	12	1
C-PMA1-5636	293	56	36	13	1.2
C-PMA1-5642	305	56	42	14	1.4
C-PMA1-5648	322	56	48	15	1.6
C-PMA1-5654	335	56	54	16	1.8
C-PMA1-5660	349	56	60	17	2
C-PMA1-6418	212	64	18	11	0.7
C-PMA1-6424	228	64	24	12	0.9
C-PMA1-6430	243	64	30	13	1.1
C-PMA1-6436	318	64	36	14	1.3
C-PMA1-6442	333	64	42	15	1.6
C-PMA1-6448	349	64	48	16	1.8
C-PMA1-6454	363	64	54	17	2
C-PMA1-6460	381	64	60	18	2.2
C-PMA1-7218	231	72	18	12	0.8
C-PMA1-7224	246	72	24	13	1
C-PMA1-7230	266	72	30	14	1.3
C-PMA1-7236	350	72	36	15	1.5
C-PMA1-7242	370	72	42	16	1.8
C-PMA1-7248	387	72	48	17	2
C-PMA1-8018	244	80	18	13	0.8
C-PMA1-8024	265	80	24	14	1.1
C-PMA1-8030	284	80	30	15	1.4
C-PMA1-8036	379	80	36	16	1.7
C-PMA1-8042	398	80	42	17	1.9
C-PMA1-8048	418	80	48	18	2.2

Code	Price	H (in.)	W (in.)	Weight (lb.)	Volume (ft ³)
Grade 2					
C-PMA2-3218	156	32	18	7	0.3
C-PMA2-3224	166	32	24	8	0.4
C-PMA2-3230	175	32	30	9	0.6
C-PMA2-3236	222	32	36	10	0.7
C-PMA2-3242	234	32	42	11	0.8
C-PMA2-3248	243	32	48	12	0.9
C-PMA2-3254	252	32	54	13	1
C-PMA2-3260	260	32	60	14	1.1
C-PMA2-4018	175	40	18	8	0.4
C-PMA2-4024	184	40	24	9	0.6
C-PMA2-4030	194	40	30	10	0.7
C-PMA2-4036	258	40	36	11	0.8
C-PMA2-4042	266	40	42	12	1
C-PMA2-4048	277	40	48	13	1.1
C-PMA2-4054	286	40	54	14	1.2
C-PMA2-4060	296	40	60	15	1.3
C-PMA2-4818	191	48	18	9	0.5
C-PMA2-4824	207	48	24	10	0.7
C-PMA2-4830	214	48	30	11	0.8
C-PMA2-4836	286	48	36	12	1
C-PMA2-4842	296	48	42	13	1.2
C-PMA2-4848	307	48	48	14	1.3
C-PMA2-4854	322	48	54	15	1.4
C-PMA2-4860	333	48	60	16	1.5
C-PMA2-5618	213	56	18	10	0.6
C-PMA2-5624	228	56	24	11	0.8

Code	Price	H (in.)	W (in.)	Weight (lb.)	Volume (ft ³)
Grade 3					
C-PMA3-3218	166	32	18	7	0.3
C-PMA3-3224	175	32	24	8	0.4
C-PMA3-3230	184	32	30	9	0.6
C-PMA3-3236	244	32	36	10	0.7
C-PMA3-3242	252	32	42	11	0.8
C-PMA3-3248	261	32	48	12	0.9
C-PMA3-3254	271	32	54	13	1
C-PMA3-3260	280	32	60	14	1.1
C-PMA3-4018	187	40	18	8	0.4
C-PMA3-4024	197	40	24	9	0.6
C-PMA3-4030	208	40	30	10	0.7
C-PMA3-4036	280	40	36	11	0.8
C-PMA3-4042	287	40	42	12	1
C-PMA3-4048	298	40	48	13	1.1
C-PMA3-4054	307	40	54	14	1.2
C-PMA3-4060	319	40	60	15	1.3
C-PMA3-4818	208	48	18	9	0.5
C-PMA3-4824	216	48	24	10	0.7
C-PMA3-4830	230	48	30	11	0.8
C-PMA3-4836	316	48	36	12	1
C-PMA3-4842	324	48	42	13	1.2
C-PMA3-4848	336	48	48	14	1.3
C-PMA3-4854	348	48	54	15	1.4
C-PMA3-4860	360	48	60	16	1.5
C-PMA3-5618	230	56	18	10	0.6
C-PMA3-5624	243	56	24	11	0.8

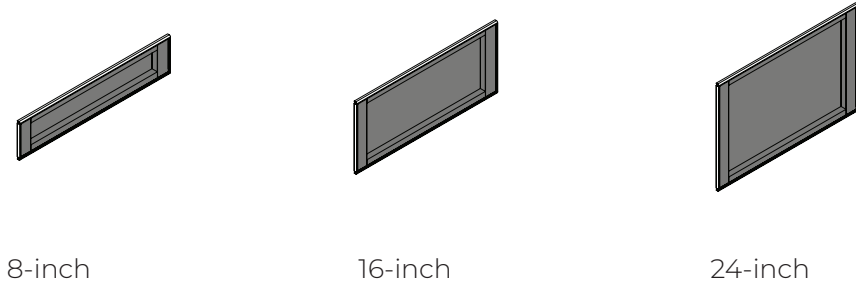

What's Included:

Acrylic tile, installation hardware.

How to Specify:

Refer to the finish card for a complete listing of metal colors.

Notes:

Acrylic tiles are priced by piece, not by pair.

Options:

acrylic options	C - clear	F - frosted	L - fluted
height	8, 16, 24		
width	18, 24, 30, 36, 42, 48, 54, 60		
tile frame finish	metal colors		

Code	Price	H (in.)	W (in.)	Weight (lb.)	Volume (ft ³)
Clear Acrylic					
C-PTGC-0818	205	8	18	2.1	0.1
C-PTGC-0824	218	8	24	2.6	0.1
C-PTGC-0830	241	8	30	3	0.1
C-PTGC-0836	259	8	36	3.5	0.1
C-PTGC-0842	280	8	42	4	0.1
C-PTGC-0848	300	8	48	4.4	0.1
C-PTGC-0854	322	8	54	4.9	0.2
C-PTGC-0860	337	8	60	5.4	0.2
C-PTGC-1618	244	16	18	3.3	0.1
C-PTGC-1624	272	16	24	4	0.1
C-PTGC-1630	296	16	30	4.7	0.2
C-PTGC-1636	328	16	36	5.5	0.2
C-PTGC-1642	359	16	42	6.2	0.2
C-PTGC-1648	383	16	48	6.9	0.3
C-PTGC-1654	409	16	54	7.6	0.3
C-PTGC-1660	435	16	60	8.3	0.4
C-PTGC-2418	294	24	18	4.5	0.2
C-PTGC-2424	328	24	24	5.5	0.2
C-PTGC-2430	364	24	30	6.5	0.3
C-PTGC-2436	400	24	36	7.4	0.3
C-PTGC-2442	438	24	42	8.1	0.4
C-PTGC-2448	470	24	48	9.4	0.4
C-PTGC-2454	502	24	54	10.3	0.5
C-PTGC-2460	546	24	60	11.3	0.5

Code	Price	H (in.)	W (in)	Weight (lb)	Volume (ft ³)
Frosted Acrylic					
C-PTGF-0818	214	8	18	2.1	0.1
C-PTGF-0824	240	8	24	2.6	0.1
C-PTGF-0830	260	8	30	3	0.1
C-PTGF-0836	282	8	36	3.5	0.1
C-PTGF-0842	307	8	42	4	0.1
C-PTGF-0848	336	8	48	4.4	0.1
C-PTGF-0854	360	8	54	4.9	0.2
C-PTGF-0860	382	8	60	5.4	0.2
C-PTGF-1618	272	16	18	3.3	0.1
C-PTGF-1624	306	16	24	4	0.1
C-PTGF-1630	342	16	30	4.7	0.2
C-PTGF-1636	382	16	36	5.5	0.2
C-PTGF-1642	421	16	42	6.2	0.2
C-PTGF-1648	454	16	48	6.9	0.3
C-PTGF-1654	491	16	54	7.6	0.3
C-PTGF-1660	526	16	60	8.3	0.4
C-PTGF-2418	333	24	18	4.5	0.2
C-PTGF-2424	382	24	24	5.5	0.2
C-PTGF-2430	431	24	30	6.5	0.3
C-PTGF-2436	478	24	36	7.4	0.3
C-PTGF-2442	531	24	42	8.5	0.4
C-PTGF-2448	578	24	48	9.4	0.4
C-PTGF-2454	628	24	54	10.3	0.5
C-PTGF-2460	683	24	60	11.3	0.5

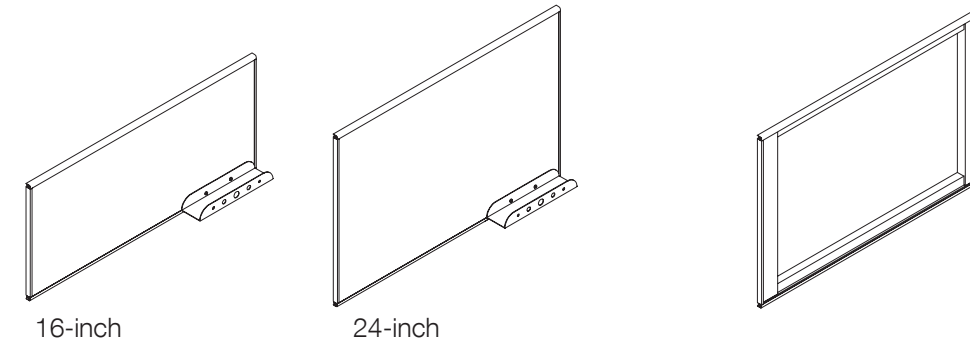

What's Included:

Magnetic whiteboard tile, installation hardware, eraser support.

How to Specify:

Refer to the metal card for a complete listing of metal colors.

Options:

height	16, 24
width	18, 24, 30, 36, 42, 48, 54, 60
finish	metal colors

Notes:

Only dry erase markers should be used on magnetic whiteboard tiles.

Code	Price	H (in.)	W (in)	Weight (lb)	Volume (ft ³)
C-PTWM-1618	266	16	18	3.2	0.1
C-PTWM-1624	286	16	24	3.1	0.1
C-PTWM-1630	306	16	30	4.5	0.2
C-PTWM-1636	328	16	36	5.2	0.2
C-PTWM-1642	357	16	42	5.9	0.2
C-PTWM-1648	379	16	48	6.5	0.3
C-PTWM-1654	400	16	54	7.2	0.3
C-PTWM-1660	422	16	60	7.9	0.4
C-PTWM-2418	303	24	18	4.4	0.2
C-PTWM-2424	329	24	24	5.3	0.2
C-PTWM-2430	354	24	30	6.2	0.3
C-PTWM-2436	383	24	36	7	0.3
C-PTWM-2442	412	24	42	7.9	0.4
C-PTWM-2448	438	24	48	8.8	0.4
C-PTWM-2454	466	24	54	9.7	0.5
C-PTWM-2460	491	24	60	10.6	0.5

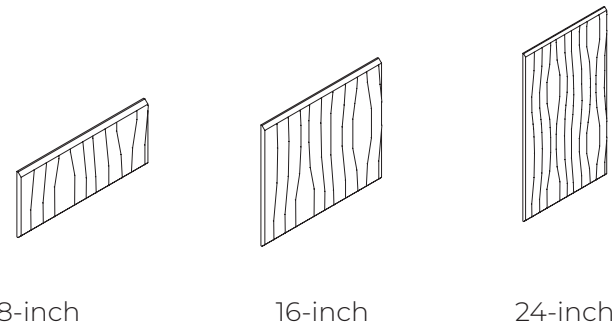

What's Included:

Laminate tile, installation hardware.

How to Specify:

Refer to the laminate card for a complete listing of laminates.

Notes:

Laminate tiles provide an easy to clean hard surface.

Grain direction is vertical.

Options:

height	8, 16, 24
width	18, 24, 30, 36, 42, 48, 54, 60
finish	laminate colors

Code	Price	H (in.)	W (in.)	Weight (lb.)	Volume (ft ³)
C-PTL0-0818	111	8	18	1.8	0.06
C-PTL0-0824	116	8	24	2.4	0.08
C-PTL0-0830	126	8	30	3.1	0.1
C-PTL0-0836	131	8	36	3.7	0.11
C-PTL0-0842	141	8	42	4.4	0.13
C-PTL0-0848	149	8	48	5	0.15
C-PTL0-0854	158	8	54	5.7	0.17
C-PTL0-0860	165	8	60	6.3	0.19
C-PTL0-1618	127	16	18	3.7	0.11
C-PTL0-1624	138	16	24	4.9	0.15
C-PTL0-1630	153	16	30	6.2	0.19
C-PTL0-1636	163	16	36	7.5	0.23
C-PTL0-1642	176	16	42	8.7	0.27
C-PTL0-1648	191	16	48	9.1	0.31
C-PTL0-1654	207	16	54	10.3	0.35
C-PTL0-1660	217	16	60	11.5	0.39
C-PTL0-2418	149	24	18	5.6	0.17
C-PTL0-2424	163	24	24	7.3	0.23
C-PTL0-2430	181	24	30	9.3	0.29
C-PTL0-2436	201	24	36	11.2	0.34
C-PTL0-2442	216	24	42	13.1	0.4
C-PTL0-2448	233	24	48	14.7	0.46
C-PTL0-2454	252	24	54	16.6	0.51
C-PTL0-2460	270	24	60	18.5	0.57

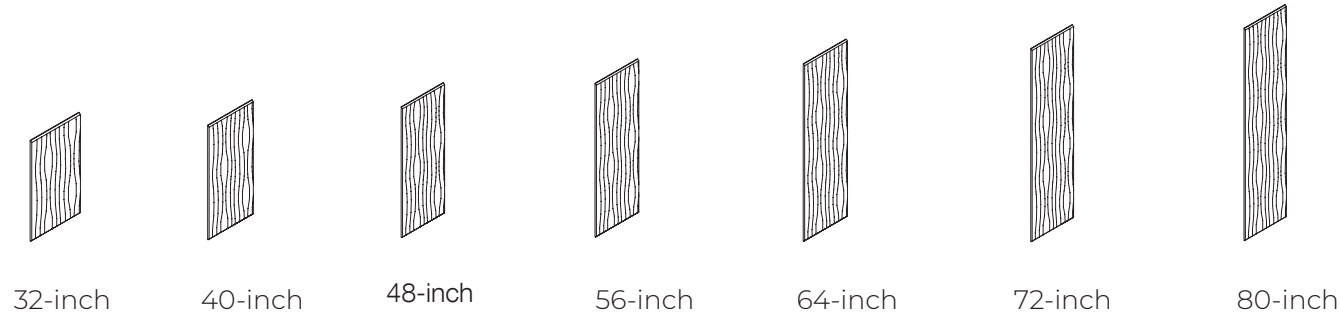

What's Included:

Monolithic laminate tile, installation hardware.

How to Specify:

Refer to the laminate card for a complete listing of laminate colors.

Options:

height	32, 40, 48, 56, 64, 72, 80
width	18, 24, 30, 36, 42, 48
finish	laminate colors

Notes:

Monolithic laminate tiles provide an easy to clean hard surface.

Monolithic laminate tiles are five inches less than the complete height of the panel frame.

Grain direction is vertical.

Code	Price	H (in.)	W (in)	Weight (lb)	Volume (ft ³)	Code	Price	H (in.)	W (in)	Weight (lb)	Volume (ft ³)
C-PTL0-3218	163	32	18	30	0.23	C-PTL0-5618	231	56	18	36	0.4
C-PTL0-3224	181	32	24	31	0.31	C-PTL0-5624	266	56	24	37	0.53
C-PTL0-3230	209	32	30	32	0.38	C-PTL0-5630	299	56	30	39	0.67
C-PTL0-3236	230	32	36	33	0.46	C-PTL0-5636	340	56	36	40	0.8
C-PTL0-3242	252	32	42	34	0.53	C-PTL0-5642	375	56	42	42	0.94
C-PTL0-3248	272	32	48	35	0.61	C-PTL0-5648	409	56	48	44	1.07
C-PTL0-3254	328	32	54	36	0.68	C-PTL0-6418	245	64	18	42	0.46
C-PTL0-3260	387	32	60	37	0.76	C-PTL0-6424	286	64	24	44	0.61
C-PTL0-4018	181	40	18	30	0.29	C-PTL0-6430	325	64	30	46	0.76
C-PTL0-4024	209	40	24	31	0.38	C-PTL0-6436	370	64	36	45	0.92
C-PTL0-4030	233	40	30	32	0.48	C-PTL0-6442	409	64	42	48	1.07
C-PTL0-4036	264	40	36	33	0.57	C-PTL0-6448	451	64	48	50	1.22
C-PTL0-4042	287	40	42	34	0.67	C-PTL0-7218	270	72	18	26	0.52
C-PTL0-4048	317	40	48	35	0.76	C-PTL0-7224	316	72	24	35	0.69
C-PTL0-4054	371	40	54	36	0.85	C-PTL0-7230	359	72	30	43	0.86
C-PTL0-4060	438	40	60	37	0.93	C-PTL0-7236	407	72	36	52	1.03
C-PTL0-4818	202	48	18	32	0.34	C-PTL0-7242	452	72	42	60	1.2
C-PTL0-4824	231	48	24	33	0.46	C-PTL0-7248	496	72	48	69	1.38
C-PTL0-4830	261	48	30	35	0.57	C-PTL0-8018	284	80	18	29	0.57
C-PTL0-4836	295	48	36	36	0.69	C-PTL0-8024	335	80	24	38	0.76
C-PTL0-4842	325	48	42	38	0.8	C-PTL0-8030	383	80	30	48	0.95
C-PTL0-4848	357	48	48	39	0.92	C-PTL0-8036	438	80	36	58	1.15
C-PTL0-4854	419	48	54	40	1.03	C-PTL0-8042	487	80	42	67	1.34
C-PTL0-4860	488	48	60	41	1.15	C-PTL0-8048	533	80	48	77	1.53

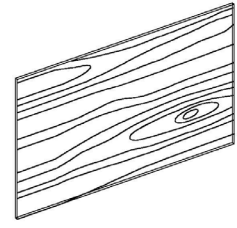

Horizontal Wood Grain

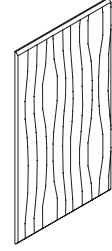

Vertical Wood Grain

What's Included:

Laminate tile, installation hardware.

How to Specify:

Refer to the laminate card for a complete listing of laminates. Specify “-WG” for horizontal woodgrain.

Options:

height	21, 29, 37, 45, 53, 61, 69, 77, 85
width	18, 24, 30, 36, 42, 48, 54, 60
finish	laminate colors

Notes:

Laminate tiles provide an easy to clean hard surface.

Grain direction is available in vertical and horizontal.

Code	Price	H (in.)	W (in.)	Weight (lb.)	Volume (ft ³)
Horizontal woodgrain					
C-PTLX-2118-WG	156	21	18	5.91	0.14
C-PTLX-2124-WG	167	21	24	7.88	0.18
C-PTLX-2130-WG	181	21	30	9.84	0.23
C-PTLX-2136-WG	196	21	36	11.81	0.27
C-PTLX-2142-WG	208	21	42	13.78	0.32
C-PTLX-2148-WG	219	21	48	15.75	0.36
C-PTLX-2154-WG	233	21	54	17.72	0.41
C-PTLX-2160-WG	246	21	60	19.69	0.46
C-PTLX-2918-WG	175	29	18	8.16	0.19
C-PTLX-2924-WG	193	29	24	10.88	0.25
C-PTLX-2930-WG	210	29	30	13.59	0.31
C-PTLX-2936-WG	228	29	36	16.31	0.38
C-PTLX-2942-WG	242	29	42	19.03	0.44
C-PTLX-2948-WG	260	29	48	21.75	0.5
C-PTLX-2954-WG	277	29	54	24.47	0.57
C-PTLX-2960-WG	294	29	60	27.19	0.63
C-PTLX-3718-WG	209	37	18	10.41	0.24
C-PTLX-3724-WG	228	37	24	13.88	0.32
C-PTLX-3730-WG	253	37	30	17.34	0.4
C-PTLX-3736-WG	277	37	36	20.81	0.48
C-PTLX-3742-WG	296	37	42	24.28	0.56
C-PTLX-3748-WG	318	37	48	27.75	0.64
C-PTLX-3760-WG	432	37	60	34.69	0.8
C-PTLX-4524-WG	253	45	24	16.88	0.39
C-PTLX-4530-WG	277	45	30	21.09	0.49
C-PTLX-4536-WG	318	45	36	25.31	0.59
C-PTLX-4548-WG	353	45	48	33.75	0.78
C-PTLX-5330-WG	324	53	30	24.84	0.58

Extended laminate tiles continued next page

Extended laminate tiles continued page 2 of 3

Code	Price	H (in.)	W (in.)	Weight (lb.)	Volume (ft ³)
Vertical Woodgrain					
C-PTLX-2118	163	21	18	5.91	0.14
C-PTLX-2124	174	21	24	7.88	0.18
C-PTLX-2130	189	21	30	9.84	0.23
C-PTLX-2136	201	21	36	11.81	0.27
C-PTLX-2142	213	21	42	13.78	0.32
C-PTLX-2148	228	21	48	15.75	0.36
C-PTLX-2154	241	21	54	17.72	0.41
C-PTLX-2160	254	21	60	19.69	0.46
C-PTLX-2918	181	29	18	8.16	0.19
C-PTLX-2924	201	29	24	10.88	0.25
C-PTLX-2930	217	29	30	13.59	0.31
C-PTLX-2936	234	29	36	16.31	0.38
C-PTLX-2942	252	29	42	19.03	0.44
C-PTLX-2948	270	29	48	21.75	0.5
C-PTLX-2954	287	29	54	24.47	0.57
C-PTLX-2960	303	29	60	27.19	0.63
C-PTLX-3718	209	37	18	10.41	0.24
C-PTLX-3724	228	37	24	13.88	0.32
C-PTLX-3730	252	37	30	17.34	0.4
C-PTLX-3736	275	37	36	20.81	0.48
C-PTLX-3742	296	37	42	24.28	0.56
C-PTLX-3748	318	37	48	27.75	0.64
C-PTLX-3754	371	37	54	31.22	0.72
C-PTLX-3760	431	37	60	34.69	0.8
C-PTLX-4518	237	45	18	12.66	0.29
C-PTLX-4524	261	45	24	16.88	0.39
C-PTLX-4530	286	45	30	21.09	0.49
C-PTLX-4536	318	45	36	25.31	0.59
C-PTLX-4542	342	45	42	29.53	0.68
C-PTLX-4548	368	45	48	33.75	0.78
C-PTLX-4554	426	45	54	37.97	0.88
C-PTLX-4560	491	45	60	42.19	0.98

Extended laminate tiles continued page 3 of 3

Code	Price	H (in.)	W (in.)	Weight (lb.)	Volume (ft ³)
C-PTLX-5318	264	53	18	14.91	0.35
C-PTLX-5324	294	53	24	19.88	0.46
C-PTLX-5330	324	53	30	24.84	0.58
C-PTLX-5336	359	53	36	29.81	0.69
C-PTLX-5342	387	53	42	34.78	0.81
C-PTLX-5348	419	53	48	39.75	0.92
C-PTLX-5354	479	53	54	44.72	1.04
C-PTLX-5360	550	53	60	49.69	1.15
C-PTLX-6118	300	61	18	17.16	0.4
C-PTLX-6124	337	61	24	22.88	0.53
C-PTLX-6130	371	61	30	28.59	0.66
C-PTLX-6136	412	61	36	34.31	0.79
C-PTLX-6142	449	61	42	40.03	0.93
C-PTLX-6148	479	61	48	45.75	1.06
C-PTLX-6918	328	69	18	19.41	0.45
C-PTLX-6924	366	69	24	25.88	0.6
C-PTLX-6930	407	69	30	32.34	0.75
C-PTLX-6936	452	69	36	38.81	0.9
C-PTLX-6942	491	69	42	45.28	1.05
C-PTLX-6948	529	69	48	51.75	1.2
C-PTLX-7718	359	77	18	21.66	0.5
C-PTLX-7724	403	77	24	28.88	0.67
C-PTLX-7730	449	77	30	36.09	0.84
C-PTLX-7736	497	77	36	43.31	1
C-PTLX-7742	540	77	42	50.53	1.17
C-PTLX-7748	581	77	48	57.75	1.34
C-PTLX-8518	383	85	18	23.91	0.55
C-PTLX-8524	431	85	24	31.88	0.74
C-PTLX-8530	479	85	30	39.84	0.92
C-PTLX-8536	534	85	36	47.81	1.11
C-PTLX-8542	581	85	42	55.78	1.29
C-PTLX-8548	631	85	48	63.75	1.48

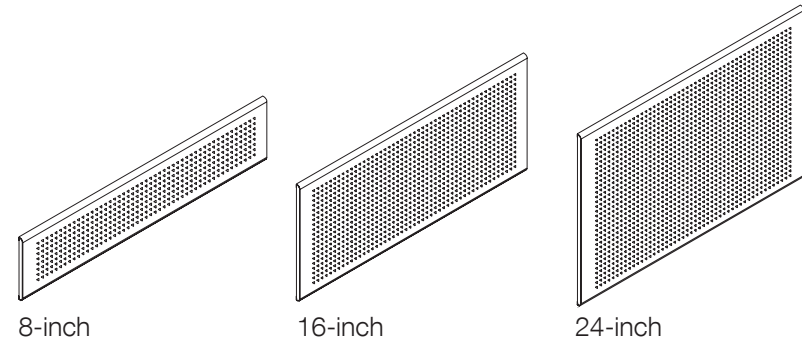

What's Included:

Perforated metal tile, installation hardware.

How to Specify:

Refer to the metal card for a complete listing of metal colors.

Options:

height	8, 16, 24
width	18, 24, 30, 36, 42, 48, 54, 60
finish	metal colors

Notes:

Perforated metal tiles provide a unique architectural element, while allowing for airflow.

CodeCode	Price	H (in.)	W (in)	Weight (lb)	Volume (ft ³)
C-PTM0-0818	107	8	18	1.5	0.1
C-PTM0-0824	114	8	24	2	0.1
C-PTM0-0830	123	8	30	2.5	0.1
C-PTM0-0836	128	8	36	3.1	0.1
C-PTM0-0842	138	8	42	3.6	0.1
C-PTM0-0848	149	8	48	4.1	0.1
C-PTM0-0854	156	8	54	4.6	0.2
C-PTM0-0860	165	8	60	5.1	0.2
C-PTM0-1618	133	16	18	3	0.1
C-PTM0-1624	148	16	24	4.1	0.1
C-PTM0-1630	155	16	30	5.1	0.2
C-PTM0-1636	166	16	36	6.1	0.2
C-PTM0-1642	178	16	42	7.1	0.2
C-PTM0-1648	193	16	48	8.1	0.3
C-PTM0-1654	208	16	54	9.1	0.3
C-PTM0-1660	218	16	60	10.2	0.4
C-PTM0-2418	166	24	18	4.6	0.2
C-PTM0-2424	187	24	24	6.1	0.2
C-PTM0-2430	207	24	30	7.6	0.3
C-PTM0-2436	220	24	36	9.2	0.3
C-PTM0-2442	243	24	42	10.7	0.4
C-PTM0-2448	265	24	48	12.2	0.4
C-PTM0-2454	284	24	54	13.7	0.5
C-PTM0-2460	300	24	60	15.2	0.5

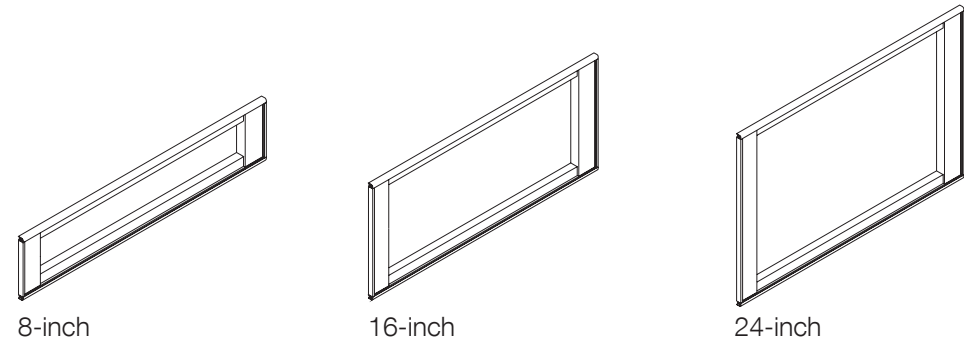

What's Included:

Pass-Through Tile, installation hardware.

How to Specify:

Refer to the metal card for a complete listing of metal colors.

Options:

height	8,16, 24
width	18, 24, 30, 36, 42, 48, 54, 60
finish	metal colors

Notes:

The pass-through tile allows data and communication cables to be shared between workstations.

CodeCode	Price	H (in.)	W (in)	Weight (lb)	Volume (ft ³)	CodeCode	Price	H (in.)	W (in)	Weight (lb)	Volume (ft ³)
C-PTO0-0818	163	8	18	1.5	0.1	C-PTO0-1642	233	16	42	3	0.2
C-PTO0-0824	175	8	24	1.7	0.1	C-PTO0-1648	243	16	48	3.2	0.3
C-PTO0-0830	187	8	30	2	0.1	C-PTO0-1654	258	16	54	3.5	0.3
C-PTO0-0836	197	8	36	2.2	0.1	C-PTO0-1660	266	16	60	3.7	0.4
C-PTO0-0842	212	8	42	2.5	0.1	C-PTO0-2418	212	24	18	2.5	0.2
C-PTO0-0848	219	8	48	2.7	0.1	C-PTO0-2424	219	24	24	2.7	0.2
C-PTO0-0854	234	8	54	3	0.2	C-PTO0-2430	233	24	30	3	0.3
C-PTO0-0860	244	8	60	3.2	0.2	C-PTO0-2436	243	24	36	3.2	0.3
C-PTO0-1618	184	16	18	2	0.1	C-PTO0-2442	259	24	42	3.5	0.4
C-PTO0-1624	197	16	24	2.2	0.1	C-PTO0-2448	271	24	48	3.7	0.4
C-PTO0-1630	209	16	30	2.5	0.2	C-PTO0-2454	281	24	54	4	0.5
C-PTO0-1636	217	16	36	2.7	0.2	C-PTO0-2460	293	24	60	4.3	0.5

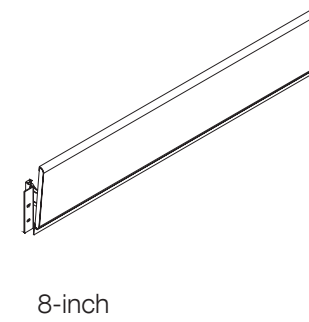

What's Included:

Fabric Flip-Up Belt-Line Tile, installation hardware.

How to Specify:

height	8
width	18, 24, 30, 36, 42, 48, 54, 60
finish	panel fabrics

Notes:

The fabric flip-up belt-line tile can be used in place of an 8-inch high tile at desk height when access to power, data and communication is required at the belt-line.

The fabric flip-up belt-line tile is compatible with panel frames that have flip-up capability.

Options:

height	8
width	18, 24, 30, 36, 42, 48, 54, 60
finish	panel fabrics

Code	Price	H (in.)	W (in)	Weight (lb)	Volume (ft ³)	Code	Price	H (in.)	W (in)	Weight (lb)	Volume (ft ³)
C-PTB0-0818	240	8	18	1.9	0.1	C-PTB0-0842	294	8	42	4.4	0.1
C-PTB0-0824	245	8	24	2.9	0.1	C-PTB0-0848	300	8	48	5	0.1
C-PTB0-0830	258	8	30	3.1	0.1	C-PTB0-0854	311	8	54	5.6	0.2
C-PTB0-0836	284	8	36	3.8	0.1	C-PTB0-0860	322	8	60	6.2	0.2

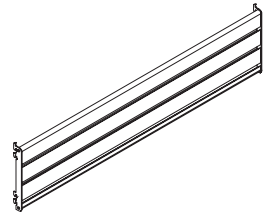

8-inch

What's Included:

Accessory Tile, installation hardware.

How to Specify:

Refer to the metal/vinyl card for a complete listing of metal colors

Options:

height	8
width	18, 24, 30, 36, 42, 48, 54, 60
finish	metal

Notes:

The accessory tile supports all personal organizers. Please refer to the accessories section [on page 166](#) of this price book for details.

Code	Price	H (in.)	W (in)	Weight (lb)	Volume (ft ³)
C-PTA0-0818	149	8	18	3	0.1
C-PTA0-0824	170	8	24	3.8	0.1
C-PTA0-0830	194	8	30	4.7	0.1
C-PTA0-0836	218	8	36	5.6	0.1
C-PTA0-0842	244	8	42	6.4	0.1
C-PTA0-0848	271	8	48	7.3	0.1
C-PTA0-0854	294	8	54	8.2	0.2
C-PTA0-0860	319	8	60	9.1	0.2



Cosmo Pricebook
August 2024
Worksurfaces

worksurfaces

<u>straight worksurface</u>	76
<u>straight worksurface with power grommet</u>	80
<u>wave return with straight end</u>	82
<u>wave return with curved end</u>	86
<u>extended corner with curved front</u>	90
<u>angled worksurface with curved front</u>	92
<u>flexed worksurface with curved front</u>	94
<u>5-sided corner worksurface with straight front</u>	96
<u>5-sided corner worksurface with curved front</u>	98
<u>6-sided corner worksurface</u>	99
<u>panel-mounted d-table</u>	100
<u>panel-mounted p-table</u>	102
<u>panel-mounted j-table</u>	104
<u>panel-mounted y-table</u>	106
<u>c-table extension</u>	108
<u>u-table extension</u>	109
<u>bridge worksurface</u>	110
<u>radiused extended surface</u>	112
<u>tempered glass transaction top</u>	113
<u>laminated countertop</u>	114

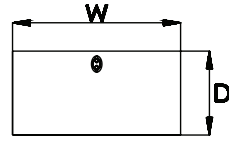
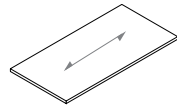

What's Included:

Straight Worksurface, grommets (24 to 48-inch worksurfaces include one grommet, 54 to 84-inch worksurfaces include two grommets, 90 to 96-inch worksurfaces include three grommets).

Notes:

Grain direction is indicated in the above illustration. If you need the laminate wood grain direction to run from front to back please see bridge worksurfaces [on page 110](#). Keyboard tray can be mounted to this worksurface. Refer to the Accessories section [on page 166](#) for details.

How to Specify:

Specify laminate color. The worksurface trim color will default to match the laminate color unless otherwise specified, see the laminate finish card for details. Not all laminate colors are available on 1.5-inch thick worksurfaces, see the laminate finish card for details. Edge profile must be specified for 1.5-inch thick worksurfaces.

Options:

thickness	C 1-inch	CT 1.5-inch
width	18, 24, 30, 36, 42, 48, 54, 60, 66, 72, 78, 84, 90, 96	
depth	18, 24, 30, 36	
surface finish	laminate colors	
edge profile (1.5-inch only)	straight	

How to Order and Read your Code:

C or CT	WSOG	18	18
product line	item	width	depth

Code	Price	H (in)	W (in.)	Wt. (lb)	Vol. (ft³)
1" Thick					
C-WS0G-1818	261	18	18	8.18	0.19
C-WS0G-1824	280	18	24	10.96	0.25
C-WS0G-1830	295	18	30	13.73	0.31
C-WS0G-1836	305	18	36	13.73	0.38
C-WS0G-2418	275	24	18	10.96	0.25
C-WS0G-2424	296	24	24	14.7	0.3
C-WS0G-2430	316	24	30	18.36	0.42
C-WS0G-2436	359	24	36	14.73	0.5
C-WS0G-3018	295	30	18	13.73	0.31
C-WS0G-3024	316	30	24	18.4	0.4
C-WS0G-3030	370	30	30	22.99	0.52
C-WS0G-3036	389	30	36	15.73	0.63
C-WS0G-3618	305	36	18	16.51	0.38
C-WS0G-3624	324	36	24	22.1	0.5
C-WS0G-3630	389	36	30	27.62	0.63
C-WS0G-3636	409	36	36	16.73	0.75
C-WS0G-4218	348	42	18	19.29	0.44
C-WS0G-4224	381	42	24	25.8	0.6
C-WS0G-4230	426	42	30	32.25	0.73
C-WS0G-4236	443	42	36	17.73	0.88
C-WS0G-4818	364	48	18	22.06	0.5
C-WS0G-4824	409	48	24	29.5	0.7
C-WS0G-4830	459	48	30	36.88	0.83
C-WS0G-4836	479	48	36	18.73	1
C-WS0G-5418	435	54	18	24.69	0.56
C-WS0G-5424	492	54	24	33	0.8
C-WS0G-5430	513	54	30	41.35	0.94

Code	Price	H (in)	W (in.)	Wt. (lb)	Vol. (ft³)
C-WS0G-5436	536	54	36	19.73	1.13
C-WS0G-6018	473	60	18	27.46	0.63
C-WS0G-6024	514	60	24	36.7	0.8
C-WS0G-6030	544	60	30	45.98	1.04
C-WS0G-6036	568	60	36	20.73	1.25
C-WS0G-6618	537	66	18	30.24	0.69
C-WS0G-6624	575	66	24	40.4	0.9
C-WS0G-6630	620	66	30	50.61	1.15
C-WS0G-6636	646	66	36	21.73	1.38
C-WS0G-7218	572	72	18	33.02	0.75
C-WS0G-7224	601	72	24	44.1	1
C-WS0G-7230	637	72	30	55.24	1.25
C-WS0G-7236	666	72	36	22.73	1.5
C-WS0G-7818	619	78	18	35.8	0.81
C-WS0G-7824	652	78	24	47.8	1.1
C-WS0G-7830	692	78	30	59.86	1.35
C-WS0G-7836	721	78	36	23.73	1.63
C-WS0G-8418	669	84	18	38.57	0.88
C-WS0G-8424	706	84	24	51.5	1.2
C-WS0G-8430	746	84	30	64.49	1.46
C-WS0G-8436	783	84	36	24.73	1.75
C-WS0G-9018	760	90	18	41.2	0.94
C-WS0G-9024	800	90	24	55.1	1.3
C-WS0G-9030	851	90	30	68.97	1.56
C-WS0G-9036	894	90	36	25.73	1.88
C-WS0G-9618	826	96	18	43.97	1
C-WS0G-9624	869	96	24	58.8	1.3
C-WS0G-9630	921	96	30	73.6	1.67
C-WS0G-9636	957	96	36	26.73	2

Code	Price	W (in.)	D 1 (in.)	Weight (lb)	Volume (ft ³)
1.5" Thick					
CT-WS0G-1818	350	18	18	8.18	0.19
CT-WS0G-1824	381	18	24	10.96	0.25
CT-WS0G-1830	395	18	30	13.73	0.31
CT-WS0G-1836	414	18	36	13.73	0.38
CT-WS0G-2418	370	24	18	10.96	0.25
CT-WS0G-2424	401	24	24	14.7	0.3
CT-WS0G-2430	426	24	30	18.36	0.42
CT-WS0G-2436	479	24	36	14.73	0.5
CT-WS0G-3018	395	30	18	13.73	0.31
CT-WS0G-3024	426	30	24	18.4	0.4
CT-WS0G-3030	500	30	30	22.99	0.52
CT-WS0G-3036	531	30	36	15.73	0.63
CT-WS0G-3618	414	36	18	16.51	0.38
CT-WS0G-3624	438	36	24	22.1	0.5
CT-WS0G-3630	531	36	30	27.62	0.63
CT-WS0G-3636	550	36	36	16.73	0.75
CT-WS0G-4218	470	42	18	19.29	0.44
CT-WS0G-4224	512	42	24	25.8	0.6
CT-WS0G-4230	573	42	30	32.25	0.73
CT-WS0G-4236	598	42	36	17.73	0.88
CT-WS0G-4818	496	48	18	22.06	0.5
CT-WS0G-4824	550	48	24	29.5	0.7
CT-WS0G-4830	620	48	30	36.88	0.83
CT-WS0G-4836	646	48	36	18.73	1
CT-WS0G-5418	585	54	18	24.69	0.56
CT-WS0G-5424	666	54	24	33	0.8
CT-WS0G-5430	694	54	30	41.35	0.94
CT-WS0G-5436	721	54	36	19.73	1.13

Code	Price	W (in.)	D 1 (in.)	Weight (lb)	Volume (ft ³)
CT-WS0G-6018	638	60	18	27.46	0.63
CT-WS0G-6024	697	60	24	36.7	0.8
CT-WS0G-6030	736	60	30	45.98	1.04
CT-WS0G-6036	770	60	36	20.73	1.25
CT-WS0G-6618	730	66	18	30.24	0.69
CT-WS0G-6624	777	66	24	40.4	0.9
CT-WS0G-6630	838	66	30	50.61	1.15
CT-WS0G-6636	876	66	36	21.73	1.38
CT-WS0G-7218	772	72	18	33.02	0.75
CT-WS0G-7224	811	72	24	44.1	1
CT-WS0G-7230	859	72	30	55.24	1.25
CT-WS0G-7236	900	72	36	22.73	1.5
CT-WS0G-7818	837	78	18	35.8	0.81
CT-WS0G-7824	882	78	24	47.8	1.1
CT-WS0G-7830	936	78	30	59.86	1.35
CT-WS0G-7836	978	78	36	23.73	1.63
CT-WS0G-8418	905	84	18	38.57	0.88
CT-WS0G-8424	952	84	24	51.5	1.2
CT-WS0G-8430	1011	84	30	64.49	1.46
CT-WS0G-8436	1057	84	36	24.73	1.75
CT-WS0G-9018	1034	90	18	41.2	0.94
CT-WS0G-9024	1084	90	24	55.1	1.3
CT-WS0G-9030	1149	90	30	68.97	1.56
CT-WS0G-9036	1202	90	36	25.73	1.88
CT-WS0G-9618	1114	96	18	43.97	1
CT-WS0G-9624	1170	96	24	58.8	1.3
CT-WS0G-9630	1246	96	30	73.6	1.67
CT-WS0G-9636	1294	96	36	26.73	2

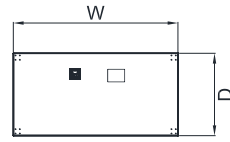
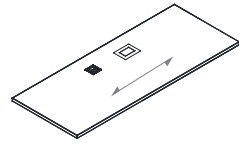

What's Included:

Straight worksurface with a cable grommet and a power grommet.

Notes:

Grain direction is indicated in the above illustration.

Keyboard tray can be mounted to this worksurface. Refer to the Accessories section [on page 166](#) for details.

How to Specify:

Specify laminate color.

The worksurface trim color will default to match the laminate color. Unless otherwise specified, see the laminate finish card for details.

Not all laminate colors are available in 1.5-inch thick worksurfaces, see the laminate finish card for details.

Edge profile must be specified for 1.5-inch thick worksurfaces

Options:

thickness	C 1-inch CT 1.5-inch
width	36, 42, 48, 54, 60, 66, 72, 78, 84, 90, 96
depth	24, 30
surface finish	laminate colors
edge profile (1.5-inch only)	straight

Code	Price	H (in)	W (in.)	Wt. (lb)	Vol. (ft ³)
1" Thick					
C-WSPG-3624	1108	36	24	17.28	0.5
C-WSPG-3630	1172	36	30	21.6	0.63
C-WSPG-4224	1164	42	24	20.16	0.58
C-WSPG-4230	1209	42	30	25.2	0.73
C-WSPG-4824	1193	48	24	23.04	0.67
C-WSPG-4830	1246	48	30	28.8	0.83
C-WSPG-5424	1277	54	24	25.92	0.75
C-WSPG-5430	1296	54	30	32.4	0.94
C-WSPG-6024	1297	60	24	28.8	0.83
C-WSPG-6030	1328	60	30	36	1.04
C-WSPG-6624	1357	66	24	31.68	0.92
C-WSPG-6630	1406	66	30	39.6	1.15
C-WSPG-7224	1382	72	24	34.56	1
C-WSPG-7230	1420	72	30	43.2	1.25
C-WSPG-7824	1435	78	24	37.44	1.08
C-WSPG-7830	1478	78	30	46.8	1.35
C-WSPG-8424	1488	84	24	40.32	1.17
C-WSPG-8430	1530	84	30	50.4	1.46
C-WSPG-9024	1586	90	24	43.2	1.25
C-WSPG-9030	1637	90	30	54	1.56
C-WSPG-9624	1651	96	24	46.08	1.33
C-WSPG-9630	1702	96	30	57.6	1.67

Code	Price	H (in)	W (in.)	Wt. (lb)	Vol. (ft ³)
1.5" Thick					
CT-WSPG-3624	1221	36	24	17.28	0.5
CT-WSPG-3630	1315	36	30	21.6	0.63
CT-WSPG-4224	1295	42	24	20.16	0.58
CT-WSPG-4230	1356	42	30	25.2	0.73
CT-WSPG-4824	1332	48	24	23.04	0.67
CT-WSPG-4830	1406	48	30	28.8	0.83
CT-WSPG-5424	1449	54	24	25.92	0.75
CT-WSPG-5430	1479	54	30	32.4	0.94
CT-WSPG-6024	1483	60	24	28.8	0.83
CT-WSPG-6030	1520	60	30	36	1.04
CT-WSPG-6624	1560	66	24	31.68	0.92
CT-WSPG-6630	1621	66	30	39.6	1.15
CT-WSPG-7224	1593	72	24	34.56	1
CT-WSPG-7230	1642	72	30	43.2	1.25
CT-WSPG-7824	1666	78	24	37.44	1.08
CT-WSPG-7830	1721	78	30	46.8	1.35
CT-WSPG-8424	1736	84	24	40.32	1.17
CT-WSPG-8430	1795	84	30	50.4	1.46
CT-WSPG-9024	1869	90	24	43.2	1.25
CT-WSPG-9030	1933	90	30	54	1.56
CT-WSPG-9624	1957	96	24	46.08	1.33
CT-WSPG-9630	2029	96	30	57.6	1.67

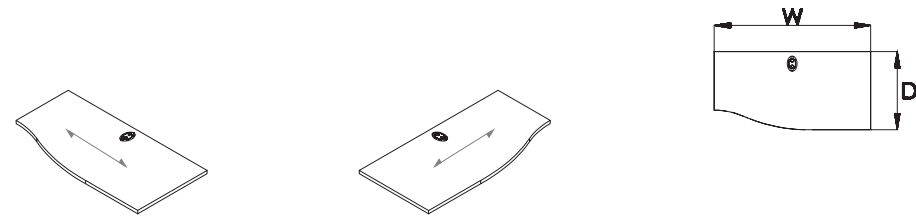

straight end
right hand

straight end
left hand

What's Included:

Wave Return, grommets
(24 to 48-inch worksurfaces include one grommet, 54 to 84-inch worksurfaces include two grommets, 90 to 96-inch worksurfaces include three grommets).

Notes:

Grain direction is indicated in the above illustration.

Worksurfaces 54-inches and longer require a horizontal surface support (CH00), which must be specified separately.

How To Specify:

Specify laminate color.

The wave return worksurface must be specified as left or right.

The worksurface trim color will default to match the laminate color unless otherwise specified, see the laminate finish card for details.

Edge profile must be specified for 1.5-inch thick worksurfaces.

Options:

thickness	C 1-inch	CT 1.5-inch
end shape	straight end	curved end
hand	R right	L left
width	30, 36, 42, 48, 54, 60, 66, 72, 78, 84, 90, 96	
depth	24, 30, 36	
surface finish	laminate colors	
edge profile (1.5-inch only)	straight	

Code	Price	H (in)	W (in.)	Wt. (lb)	Vol. (ft ³)	Code	Price	H (in)	W (in.)	Wt. (lb)	Vol. (ft ³)
1" Thick						C-WW0G-6624-L	605	66	24	40.42	0.92
C-WW0G-3024-L	324	30	24	18.36	0.42	C-WW0G-6624-R	605	66	24	40.42	0.92
C-WW0G-3024-R	324	30	24	18.36	0.42	C-WW0G-6630-L	642	66	30	50.61	1.15
C-WW0G-3030-L	389	30	30	22.99	0.52	C-WW0G-6630-R	642	66	30	50.61	1.15
C-WW0G-3030-R	389	30	30	22.99	0.52	C-WW0G-6636-L	672	66	36	75.91	2.06
C-WW0G-3036-L	421	30	36	34.48	0.94	C-WW0G-6636-R	672	66	36	75.91	2.06
C-WW0G-3036-R	421	30	36	34.48	0.94	C-WW0G-7224-L	622	72	24	44.13	1
C-WW0G-3624-L	336	36	24	22.99	0.5	C-WW0G-7224-R	622	72	24	44.13	1
C-WW0G-3624-R	336	36	24	22.99	0.5	C-WW0G-7230-L	664	72	30	55.24	1.25
C-WW0G-3630-L	419	36	30	27.62	0.63	C-WW0G-7230-R	664	72	30	55.24	1.25
C-WW0G-3630-R	419	36	30	27.62	0.63	C-WW0G-7236-L	688	72	36	82.85	2.25
C-WW0G-3636-L	451	36	36	41.43	1.13	C-WW0G-7236-R	688	72	36	82.85	2.25
C-WW0G-3636-R	451	36	36	41.43	1.13	C-WW0G-7824-L	681	78	24	47.83	1.08
C-WW0G-4224-L	401	42	24	25.77	0.58	C-WW0G-7824-R	681	78	24	47.83	1.08
C-WW0G-4224-R	401	42	24	25.77	0.58	C-WW0G-7830-L	706	78	30	59.86	1.35
C-WW0G-4230-L	445	42	30	32.25	0.73	C-WW0G-7830-R	706	78	30	59.86	1.35
C-WW0G-4230-R	445	42	30	32.25	0.73	C-WW0G-7836-L	735	78	36	89.79	2.44
C-WW0G-4236-L	474	42	36	48.37	1.31	C-WW0G-7836-R	735	78	36	89.79	2.44
C-WW0G-4236-R	474	42	36	48.37	1.31	C-WW0G-8424-L	738	84	24	61.53	1.17
C-WW0G-4824-L	428	48	24	29.47	0.67	C-WW0G-8424-R	738	84	24	61.53	1.17
C-WW0G-4824-R	428	48	24	29.47	0.67	C-WW0G-8430-L	757	84	30	64.49	1.46
C-WW0G-4830-L	484	48	30	36.88	0.83	C-WW0G-8430-R	757	84	30	64.49	1.46
C-WW0G-4830-R	484	48	30	36.88	0.83	C-WW0G-8436-L	795	84	36	96.74	2.63
C-WW0G-4836-L	511	48	36	55.31	1.5	C-WW0G-8436-R	795	84	36	96.74	2.63
C-WW0G-4836-R	511	48	36	55.31	1.5	C-WW0G-9024-L	837	90	24	55.08	1.25
C-WW0G-5424-L	492	54	24	33.02	0.75	C-WW0G-9024-R	837	90	24	55.08	1.25
C-WW0G-5424-R	492	54	24	33.02	0.75	C-WW0G-9030-L	858	90	30	68.97	1.56
C-WW0G-5430-L	534	54	30	41.35	0.94	C-WW0G-9030-R	858	90	30	68.97	1.56
C-WW0G-5430-R	534	54	30	41.35	0.94	C-WW0G-9036-L	900	90	36	103.45	2.81
C-WW0G-5436-L	564	54	36	62.02	1.69	C-WW0G-9036-R	900	90	36	103.45	2.81
C-WW0G-5436-R	564	54	36	62.02	1.69	C-WW0G-9624-L	908	96	24	88.17	2
C-WW0G-6024-L	540	60	24	36.72	0.83	C-WW0G-9624-R	908	96	24	88.17	2
C-WW0G-6024-R	540	60	24	36.72	0.83	C-WW0G-9630-L	934	96	30	103.45	2.5
C-WW0G-6030-L	568	60	30	45.98	1.04	C-WW0G-9630-R	934	96	30	103.45	2.5
C-WW0G-6030-R	568	60	30	45.98	1.04	C-WW0G-9636-L	969	96	36	110.4	3
C-WW0G-6036-L	597	60	36	68.97	1.88	C-WW0G-9636-R	969	96	36	110.4	3
C-WW0G-6036-R	597	60	36	68.97	1.88						

Code	Price	W (in.)	D 1 (in.)	Weight (lb)	Volume (ft ³)
1.5" Thick					
CT-WW0G-3024-L	438	30	24	18.36	0.42
CT-WW0G-3024-R	438	30	24	18.36	0.42
CT-WW0G-3030-L	531	30	30	22.99	0.52
CT-WW0G-3030-R	531	30	30	22.99	0.52
CT-WW0G-3036-L	572	30	36	34.48	0.94
CT-WW0G-3036-R	572	30	36	34.48	0.94
CT-WW0G-3624-L	457	36	24	22.99	0.5
CT-WW0G-3624-R	457	36	24	22.99	0.5
CT-WW0G-3630-L	567	36	30	27.62	0.63
CT-WW0G-3630-R	567	36	30	27.62	0.63
CT-WW0G-3636-L	610	36	36	41.43	1.13
CT-WW0G-3636-R	610	36	36	41.43	1.13
CT-WW0G-4224-L	537	42	24	25.77	0.58
CT-WW0G-4224-R	537	42	24	25.77	0.58
CT-WW0G-4230-L	603	42	30	32.25	0.73
CT-WW0G-4230-R	603	42	30	32.25	0.73
CT-WW0G-4236-L	639	42	36	48.37	1.31
CT-WW0G-4236-R	639	42	36	48.37	1.31
CT-WW0G-4824-L	578	48	24	29.47	0.67
CT-WW0G-4824-R	578	48	24	29.47	0.67
CT-WW0G-4830-L	651	48	30	36.88	0.83
CT-WW0G-4830-R	651	48	30	36.88	0.83
CT-WW0G-4836-L	689	48	36	55.31	1.5
CT-WW0G-4836-R	689	48	36	55.31	1.5
CT-WW0G-5424-L	666	54	24	33.02	0.75
CT-WW0G-5424-R	666	54	24	33.02	0.75
CT-WW0G-5430-L	720	54	30	41.35	0.94
CT-WW0G-5430-R	720	54	30	41.35	0.94
CT-WW0G-5436-L	757	54	36	62.02	1.69
CT-WW0G-5436-R	757	54	36	62.02	1.69
CT-WW0G-6024-L	731	60	24	36.72	0.83
CT-WW0G-6024-R	731	60	24	36.72	0.83
CT-WW0G-6030-L	770	60	30	45.98	1.04
CT-WW0G-6030-R	770	60	30	45.98	1.04
CT-WW0G-6036-L	800	60	36	68.97	1.88
CT-WW0G-6036-R	800	60	36	68.97	1.88

Code	Price	W (in.)	D 1 (in.)	Weight (lb)	Volume (ft ³)
CT-WW0G-6624-L	818	66	24	40.42	0.92
CT-WW0G-6624-R	818	66	24	40.42	0.92
CT-WW0G-6630-L	869	66	30	50.61	1.15
CT-WW0G-6630-R	869	66	30	50.61	1.15
CT-WW0G-6636-L	906	66	36	75.91	2.06
CT-WW0G-6636-R	906	66	36	75.91	2.06
CT-WW0G-7224-L	843	72	24	44.13	1
CT-WW0G-7224-R	843	72	24	44.13	1
CT-WW0G-7230-L	896	72	30	55.24	1.25
CT-WW0G-7230-R	896	72	30	55.24	1.25
CT-WW0G-7236-L	932	72	36	82.85	2.25
CT-WW0G-7236-R	932	72	36	82.85	2.25
CT-WW0G-7824-L	919	78	24	47.83	1.08
CT-WW0G-7824-R	919	78	24	47.83	1.08
CT-WW0G-7830-L	952	78	30	59.86	1.35
CT-WW0G-7830-R	952	78	30	59.86	1.35
CT-WW0G-7836-L	989	78	36	89.79	2.44
CT-WW0G-7836-R	989	78	36	89.79	2.44
CT-WW0G-8424-L	991	84	24	61.53	1.17
CT-WW0G-8424-R	991	84	24	61.53	1.17
CT-WW0G-8430-L	1024	84	30	64.49	1.46
CT-WW0G-8430-R	1024	84	30	64.49	1.46
CT-WW0G-8436-L	1074	84	36	96.74	2.63
CT-WW0G-8436-R	1074	84	36	96.74	2.63
CT-WW0G-9024-L	1128	90	24	55.08	1.25
CT-WW0G-9024-R	1128	90	24	55.08	1.25
CT-WW0G-9030-L	1158	90	30	68.97	1.56
CT-WW0G-9030-R	1158	90	30	68.97	1.56
CT-WW0G-9036-L	1211	90	36	103.45	2.81
CT-WW0G-9036-R	1211	90	36	103.45	2.81
CT-WW0G-9624-L	1227	96	24	88.17	2
CT-WW0G-9624-R	1227	96	24	88.17	2
CT-WW0G-9630-L	1260	96	30	103.45	2.5
CT-WW0G-9630-R	1260	96	30	103.45	2.5
CT-WW0G-9636-L	1309	96	36	110.4	3
CT-WW0G-9636-R	1309	96	36	110.4	3

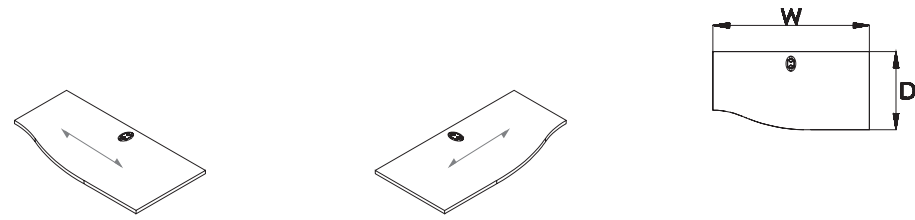

curved end right hand

curved end left hand

What's Included:

Wave Return, grommets (24 to 48-inch worksurfaces include one grommet, 54 to 84-inch worksurfaces include two grommets, 90 to 96-inch worksurfaces include three grommets).

Notes:

Grain direction is indicated in the above illustration.

Worksurfaces 54-inches and longer require a horizontal surface support (CH00), which must be specified separately.

How To Specify:

Specify laminate color.

The wave return work surface must be specified as left or right.

The work surface trim color will default to match the laminate color unless otherwise specified, see the laminate finish card for details.

Edge profile must be specified for 1.5-inch thick worksurfaces.

Options:

thickness	C 1-inch	CT 1.5-inch
end shape	straight end	curved end
hand	R right	L left
width	30, 36, 42, 48, 54, 60, 66, 72, 78, 84, 90, 96	
depth	24, 30, 36	
surface finish	laminate colors	
edge profile (1.5-inch only)	straight	

Code	Price	H (in)	W (in.)	Wt. (lb)	Vol. (ft ³)	Code	Price	H (in)	W (in.)	Wt. (lb)	Vol. (ft ³)
1" Thick - Right Hand						1" Thick - Left Hand					
C-WWRG-3024-R	337	30	24	18.36	0.42	C-WWLG-3024-L	337	30	24	18.36	0.42
C-WWRG-3030-R	412	30	30	22.99	0.52	C-WWLG-3030-L	412	30	30	22.99	0.52
C-WWRG-3624-R	357	36	24	22.99	0.5	C-WWLG-3624-L	357	36	24	22.99	0.5
C-WWRG-3630-R	440	36	30	27.62	0.63	C-WWLG-3630-L	440	36	30	27.62	0.63
C-WWRG-4224-R	419	42	24	25.77	0.58	C-WWLG-4224-L	419	42	24	25.77	0.58
C-WWRG-4230-R	471	42	30	32.25	0.73	C-WWLG-4230-L	471	42	30	32.25	0.73
C-WWRG-4824-R	451	48	24	29.47	0.67	C-WWLG-4824-L	451	48	24	29.47	0.67
C-WWRG-4830-R	509	48	30	36.88	0.83	C-WWLG-4830-L	509	48	30	36.88	0.83
C-WWRG-5424-R	514	54	24	33.02	0.75	C-WWLG-5424-L	514	54	24	33.02	0.75
C-WWRG-5430-R	564	54	30	41.35	0.94	C-WWLG-5430-L	564	54	30	41.35	0.94
C-WWRG-6024-R	568	60	24	36.72	0.83	C-WWLG-6024-L	568	60	24	36.72	0.83
C-WWRG-6030-R	597	60	30	45.98	1.04	C-WWLG-6030-L	597	60	30	45.98	1.04
C-WWRG-6624-R	633	66	24	40.42	0.92	C-WWLG-6624-L	633	66	24	40.42	0.92
C-WWRG-6630-R	676	66	30	50.61	1.15	C-WWLG-6630-L	676	66	30	50.61	1.15
C-WWRG-7224-R	651	72	24	44.13	1	C-WWLG-7224-L	651	72	24	44.13	1
C-WWRG-7230-R	689	72	30	55.24	1.25	C-WWLG-7230-L	689	72	30	55.24	1.25
C-WWRG-7824-R	708	78	24	47.83	1.08	C-WWLG-7824-L	708	78	24	47.83	1.08
C-WWRG-7830-R	739	78	30	59.86	1.35	C-WWLG-7830-L	739	78	30	59.86	1.35
C-WWRG-8424-R	770	84	24	61.53	1.17	C-WWLG-8424-L	770	84	24	61.53	1.17
C-WWRG-8430-R	791	84	30	64.49	1.46	C-WWLG-8430-L	791	84	30	64.49	1.46
C-WWRG-9024-R	869	90	24	55.08	1.25	C-WWLG-9024-L	869	90	24	55.08	1.25
C-WWRG-9030-R	897	90	30	68.97	1.56	C-WWLG-9030-L	897	90	30	68.97	1.56

Code	Price	W (in.)	D 1 (in.)	Weight (lb)	Volume (ft ³)
1.5" Thick - Right Hand					
CT-WWRG-3024-R	458	30	24	18.36	0.42
CT-WWRG-3030-R	561	30	30	22.99	0.52
CT-WWRG-3624-R	475	36	24	22.99	0.5
CT-WWRG-3630-R	597	36	30	27.62	0.63
CT-WWRG-4224-R	567	42	24	25.77	0.58
CT-WWRG-4230-R	633	42	30	32.25	0.73
CT-WWRG-4824-R	610	48	24	29.47	0.67
CT-WWRG-4830-R	685	48	30	36.88	0.83
CT-WWRG-5424-R	697	54	24	33.02	0.75
CT-WWRG-5430-R	757	54	30	41.35	0.94
CT-WWRG-6024-R	770	60	24	36.72	0.83
CT-WWRG-6030-R	800	60	30	45.98	1.04
CT-WWRG-6624-R	855	66	24	40.42	0.92
CT-WWRG-6630-R	908	66	30	50.61	1.15
CT-WWRG-7224-R	881	72	24	44.13	1
CT-WWRG-7230-R	933	72	30	55.24	1.25
CT-WWRG-7824-R	956	78	24	47.83	1.08
CT-WWRG-7830-R	995	78	30	59.86	1.35
CT-WWRG-8424-R	1037	84	24	61.53	1.17
CT-WWRG-8430-R	1068	84	30	64.49	1.46
CT-WWRG-9024-R	1170	90	24	55.08	1.25
CT-WWRG-9030-R	1207	90	30	68.97	1.56

Code	Price	W (in.)	D 1 (in.)	Weight (lb)	Volume (ft ³)
1.5" Thick - Left Hand					
CT-WWLG-3024-L	458	30	24	18.36	0.42
CT-WWLG-3030-L	561	30	30	22.99	0.52
CT-WWLG-3624-L	475	36	24	22.99	0.5
CT-WWLG-3630-L	597	36	30	27.62	0.63
CT-WWLG-4224-L	567	42	24	25.77	0.58
CT-WWLG-4230-L	633	42	30	32.25	0.73
CT-WWLG-4824-L	610	48	24	29.47	0.67
CT-WWLG-4830-L	685	48	30	36.88	0.83
CT-WWLG-5424-L	697	54	24	33.02	0.75
CT-WWLG-5430-L	757	54	30	41.35	0.94
CT-WWLG-6024-L	770	60	24	36.72	0.83
CT-WWLG-6030-L	800	60	30	45.98	1.04
CT-WWLG-6624-L	855	66	24	40.42	0.92
CT-WWLG-6630-L	908	66	30	50.61	1.15
CT-WWLG-7224-L	881	72	24	44.13	1
CT-WWLG-7230-L	933	72	30	55.24	1.25
CT-WWLG-7824-L	956	78	24	47.83	1.08
CT-WWLG-7830-L	995	78	30	59.86	1.35
CT-WWLG-8424-L	1037	84	24	61.53	1.17
CT-WWLG-8430-L	1068	84	30	64.49	1.46
CT-WWLG-9024-L	1170	90	24	55.08	1.25
CT-WWLG-9030-L	1207	90	30	68.97	1.56

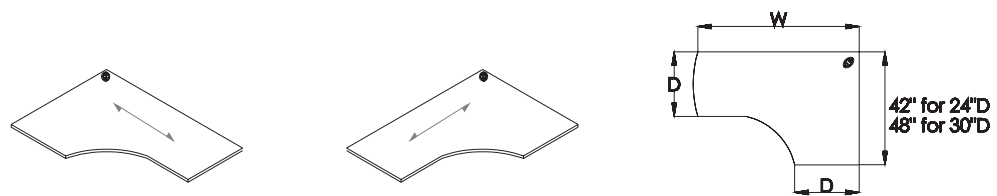

straight end
right hand

straight end
left hand

What's Included:

Extended Corner with curved front, grommets (48-inch worksurfaces include one grommet, 54-inch worksurfaces and above include two grommets).

Notes:

Grain direction is indicated in the above illustration.

Worksurfaces 54-inches and longer require a horizontal surface support (CH00), which must be specified separately.

How To Specify:

Specify laminate color.

The straight worksurface with curved end must be specified as left or right. When the straight end is specified, the handed end will be longer. When the curved end is specified, the handed end will be longer and curved.

The worksurface trim color will default to match the laminate color unless otherwise specified, see the laminate finish card for details.

Edge profile must be specified for 1.5-inch thick worksurfaces.

Keyboard tray can be mounted to this worksurface. Refer to the Accessories section [on page 166](#) for details.

Options:

thickness	C 1-inch	CT 1.5-inch
hand	R right	L left
width	36, 42, 48	
depth	18, 24, 30	
length	48, 54, 60, 66, 72	
surface finish	laminate colors	
edge profile (1.5-inch only)	straight	

Code	Price	H (in)	W (in.)	Wt. (lb)	Vol. (ft ³)	Code	Price	H (in)	W (in.)	Wt. (lb)	Vol. (ft ³)
1" Thick - Straight End						1.5" Thick - Straight End					
C-W5E0-4218-L	707	42	18	29.09	0.8	CT-W5E0-4218-L	954	42	18	29.09	0.8
C-W5E0-4218-R	707	42	18	29.09	0.8	CT-W5E0-4218-R	954	42	18	29.09	0.8
C-W5E0-4818-L	742	48	18	33.23	0.9	CT-W5E0-4818-L	1003	48	18	33.23	0.9
C-W5E0-4818-R	742	48	18	33.23	0.9	CT-W5E0-4818-R	1003	48	18	33.23	0.9
C-W5E0-4824-L	779	48	24	38.77	1.2	CT-W5E0-4824-L	1049	48	24	38.77	1.2
C-W5E0-4824-R	779	48	24	38.77	1.2	CT-W5E0-4824-R	1049	48	24	38.77	1.2
C-W5E0-5418-L	790	54	18	37.38	1	CT-W5E0-5418-L	1067	54	18	37.38	1
C-W5E0-5418-R	790	54	18	37.38	1	CT-W5E0-5418-R	1067	54	18	37.38	1
C-W5E0-5424-L	819	54	24	43.62	1.3	CT-W5E0-5424-L	1105	54	24	43.62	1.3
C-W5E0-5424-R	819	54	24	43.62	1.3	CT-W5E0-5424-R	1105	54	24	43.62	1.3
C-W5E0-5430-L	894	54	30	49.85	1.5	CT-W5E0-5430-L	1202	54	30	49.85	1.5
C-W5E0-5430-R	894	54	30	49.85	1.5	CT-W5E0-5430-R	1202	54	30	49.85	1.5
C-W5E0-6018-L	823	60	18	41.54	1.1	CT-W5E0-6018-L	1112	60	18	41.54	1.1
C-W5E0-6018-R	823	60	18	41.54	1.1	CT-W5E0-6018-R	1112	60	18	41.54	1.1
C-W5E0-6024-L	864	60	24	48.46	1.5	CT-W5E0-6024-L	1167	60	24	48.46	1.5
C-W5E0-6024-R	864	60	24	48.46	1.5	CT-W5E0-6024-R	1167	60	24	48.46	1.5
C-W5E0-6030-L	965	60	30	55.38	1.7	CT-W5E0-6030-L	1308	60	30	55.38	1.7
C-W5E0-6030-R	965	60	30	55.38	1.7	CT-W5E0-6030-R	1308	60	30	55.38	1.7
C-W5E0-6630-L	1040	66	30	60.92	1.9	CT-W5E0-6630-L	1431	66	30	60.92	1.9
C-W5E0-6630-R	1040	66	30	60.92	1.9	CT-W5E0-6630-R	1431	66	30	60.92	1.9
C-W5E0-7230-L	1111	72	30	66.46	2.1	CT-W5E0-7230-L	1531	72	30	66.46	2.1
C-W5E0-7230-R	1111	72	30	66.46	2.1	CT-W5E0-7230-R	1531	72	30	66.46	2.1

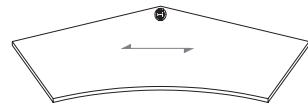

straight ends

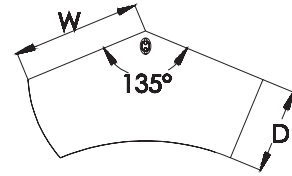

What's Included:

Angled Worksurface with curved front (135-degree), grommet

Notes:

Grain direction is indicated in the above illustration.

How To Specify:

Specify laminate color.

The worksurface trim color will default to match the laminate color unless otherwise specified, see the laminate finish card for details.

Edge profile must be specified for 1.5-inch thick worksurfaces.

Keyboard tray can be mounted to this worksurface. Refer to the Accessories section [on page 166](#) for details.

Options:

thickness	C 1-inch	CT 1.5-inch
end shape	straight	
width	24, 30, 36, 42, 48	
depth	18, 24, 30	
surface finish	laminate colors	
edge profile (1.5-inch only)	straight	

Code	Price	W (in.)	D 1 (in.)	Weight (lb)	Volume (ft ³)
1" Thick					
C-WA00-2418	484	24	18	20	0.47
C-WA00-2424	546	24	24	24	0.56
C-WA00-3018	638	30	18	26	0.67
C-WA00-3024	665	30	24	28	0.75
C-WA00-3030	756	30	30	30	0.84
C-WA00-3618	720	36	18	28	0.91
C-WA00-3624	832	36	24	30	1.01
C-WA00-3630	946	36	30	32	1.11
C-WA00-4218	828	42	18	30	1.1
C-WA00-4224	922	42	24	32	1.2
C-WA00-4230	1009	42	30	34	1.4
C-WA00-4818	1001	48	18	32	1.3
C-WA00-4824	1135	48	24	34	1.4
C-WA00-4830	1242	48	30	36	1.6
1.5" Thick					
CT-WA00-2418	651	24	18	20	0.47
CT-WA00-2424	738	24	24	24	0.56
CT-WA00-3018	863	30	18	26	0.67
CT-WA00-3024	897	30	24	28	0.75
CT-WA00-3030	1021	30	30	30	0.84
CT-WA00-3618	976	36	18	28	0.91
CT-WA00-3624	1119	36	24	30	1.01
CT-WA00-3630	1274	36	30	32	1.11
CT-WA00-4218	1112	42	18	30	1.1
CT-WA00-4224	1251	42	24	32	1.2
CT-WA00-4230	1380	42	30	34	1.4
CT-WA00-4818	1371	48	18	32	1.3
CT-WA00-4824	1560	48	24	34	1.4
CT-WA00-4830	1721	48	30	36	1.6



straight ends

What's Included:

Flexed Worksurface with curved front (120-degree), grommet

Notes:

Grain direction is indicated in the above illustration.

How To Specify:

Specify laminate color.

The worksurface trim color will default to match the laminate color unless otherwise specified, see the laminate finish card for details.

Edge profile must be specified for 1.5-inch thick worksurfaces.

Keyboard tray can be mounted to this worksurface. Refer to the Accessories section [on page 166](#) for details.

Options:

thickness	C 1-inch	CT 1.5-inch
end shape	O straight	
width	24, 30, 36, 42, 48, 54	
depth	18, 24, 30	
surface finish	laminate colors	
edge profile (1.5-inch only)	straight	

Code	Price	W (in.)	D 1 (in.)	Weight (lb)	Volume (ft ³)
1" Thick					
C-WF00-2418	474	24	18	5.18	0.25
C-WF00-3018	578	30	18	6.48	0.31
C-WF00-3024	667	36	18	7.78	0.38
C-WF00-3618	731	42	18	28	0.44
C-WF00-3624	819	48	18	10.37	0.5
C-WF00-3630	832	54	18	11.66	0.56
C-WF00-4218	828	30	24	8.64	0.42
C-WF00-4224	905	36	24	10.37	0.5
C-WF00-4230	923	42	24	12.1	0.58
C-WF00-4818	1015	48	24	13.82	0.67
C-WF00-4824	1119	54	24	15.55	0.75
C-WF00-4830	1143	36	30	12.96	0.63
C-WF00-5418	1188	42	30	15.12	0.73
C-WF00-5424	1293	48	30	17.28	0.83
C-WF00-5430	1319	54	30	19.44	0.94
1.5" Thick					
CT-WF00-2418	639	24	18	5.18	0.25
CT-WF00-3018	782	30	18	6.48	0.31
CT-WF00-3024	901	36	18	7.78	0.38
CT-WF00-3618	988	42	18	28	0.44
CT-WF00-3624	1105	48	18	10.37	0.5
CT-WF00-3630	1119	54	18	11.66	0.56
CT-WF00-4218	1114	30	24	8.64	0.42
CT-WF00-4224	1227	36	24	10.37	0.5
CT-WF00-4230	1260	42	24	12.1	0.58
CT-WF00-4818	1399	48	24	13.82	0.67
CT-WF00-4824	1542	54	24	15.55	0.75
CT-WF00-4830	1586	36	30	12.96	0.63
CT-WF00-5418	1642	42	30	15.12	0.73
CT-WF00-5424	1799	48	30	17.28	0.83
CT-WF00-5430	1849	54	30	19.44	0.94

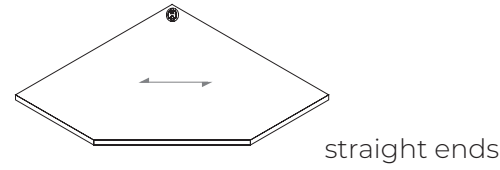

What's Included:

5-Sided Corner Workspace with straight front, grommet

Notes:

Grain direction is indicated in the above illustration.

How To Specify:

Specify laminate color.

The worksurface trim color will default to match the laminate color unless otherwise specified, see the laminate finish card for details.

Edge profile must be specified for 1.5-inch thick worksurfaces.

Keyboard tray can be mounted to this worksurface. Refer to the Accessories section [on page 166](#) for details.

Options:

thickness	C 1-inch	CT 1.5-inch
width	36, 42, 48	
depth	18, 24, 30	
surface finish	laminate colors	
edge profile (1.5-inch only)	straight	

Code	Price	W (in.)	D 1 (in.)	Weight (lb)	Volume (ft ³)
1" Thick					
C-W5S0-3618	637	36	18	39.94	1.13
C-W5S0-3624	637	36	24	40.5	1.13
C-W5S0-4224	770	42	24	57.99	1.53
C-W5S0-4824	800	48	24	71.18	2
C-W5S0-4830	800	48	30	78.82	2
1.5" Thick					
CT-W5S0-3618	859	36	18	39.94	1.13
CT-W5S0-3624	859	36	24	40.5	1.13
CT-W5S0-4224	1037	42	24	57.99	1.53
CT-W5S0-4824	1084	48	24	71.18	2
CT-W5S0-4830	1084	48	30	78.82	2

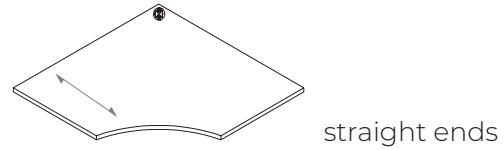

What's Included:

5-Sided Corner Workspace with curved front, grommet

Notes:

Grain direction is indicated in the above illustration.

Options:

thickness	C 1-inch	CT 1.5-inch
width	36, 42, 48	
depth	18, 24, 30	
surface finish	laminate colors	
edge profile (1.5-inch only)	straight	

Code	Price	W (in.)	D 1 (in.)	Weight (lb)	Volume (ft ³)
1" Thick					
C-W5C0-3618	637	36	18	26.63	0.75
C-W5C0-3624	637	36	24	27	0.75
C-W5C0-4224	770	42	24	38.66	1.02
C-W5C0-4824	800	48	24	47.45	1.33
C-W5C0-4830	800	48	30	52.55	1.33
1.5" Thick					
CT-W5C0-3618	859	36	18	26.63	0.75
CT-W5C0-3624	859	36	24	27	0.75
CT-W5C0-4224	1037	42	24	38.66	1.02
CT-W5C0-4824	1084	48	24	47.45	1.33
CT-W5C0-4830	1084	48	30	52.55	1.33

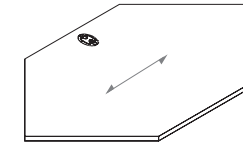

straight front

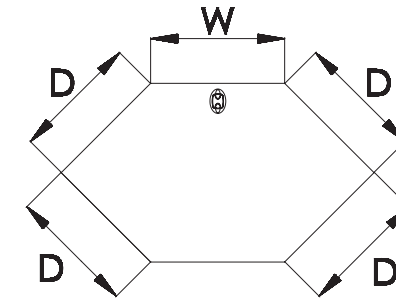

What's Included:

6-Sided Corner Workspace with grommet.

Notes:

Grain direction is indicated in the above illustration.

How To Specify:

Specify laminate color.

The workspace trim color will default to match the laminate color unless otherwise specified, see the laminate finish card for details.

Edge profile must be specified for 1.5-inch thick worksurfaces.

Keyboard tray can be mounted to this workspace. Refer to the Accessories section [on page 166](#) for details.

Options:

thickness	C 1-inch	CT 1.5-inch
end shape	O straight	
width	24	
depth	24, 30	
surface finish	laminate colors	
edge profile (1.5-inch only)	straight	

Code	Price	W (in.)	D 1 (in.)	Weight (lb)	Volume (ft ³)
1" Thick					
C-W6SG-2424	779	24	24	27	0.75
C-W6SG-3024	819	30	24	27	0.87
1.5" Thick					
CT-W6CG-2424	1049	24	24	27	0.75
CT-W6CG-3024	1105	30	24	27	0.87

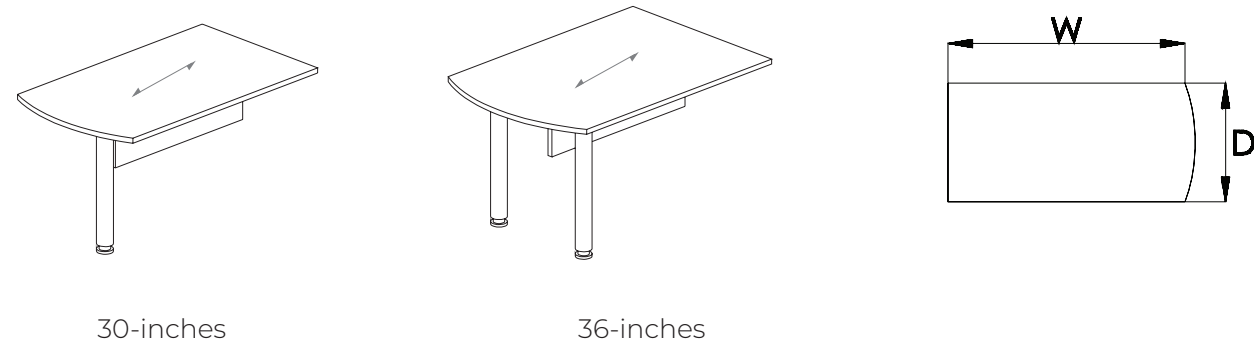

What's Included:

Panel-Mounted D-Table, metal support post, laminate partial modesty panel.

Notes:

Grain direction is indicated in the above illustration.

How To Specify:

Specify laminate color.

The worksurface trim color will default to match the laminate color unless otherwise specified, see the laminate finish card for details.

Edge profile must be specified for 1.5-inch thick worksurfaces.

The color of the modesty panel will default to match the worksurface.

Options:

thickness	C 1-inch	CT 1.5-inch
width	60, 66, 72, 78, 84	
depth	30, 36	
surface finish	laminate colors	
edge profile (1.5-inch only)	straight	
support finish	metal colors	

How to Order and Read your Code:

C or CT	WD00	72	36
product line	item	width	depth

Code	Price	H (in)	W (in.)	Wt. (lb)	Vol. (ft ³)	Code	Price	H (in)	W (in.)	Wt. (lb)	Vol. (ft ³)
1" Thick - Without Grommet						1.5" Thick - Without Grommet					
C-WD00-6030	779	60	30	63.27	1.04	CT-WD00-6030	933	60	30	63.27	1.04
C-WD00-6036	853	60	36	78.14	1.25	CT-WD00-6036	1024	60	36	78.14	1.25
C-WD00-6630	919	66	30	69.75	1.15	CT-WD00-6630	1102	66	30	69.75	1.15
C-WD00-6636	1009	66	36	85.54	1.38	CT-WD00-6636	1209	66	36	85.54	1.38
C-WD00-7230	990	72	30	76.22	1.25	CT-WD00-7230	1189	72	30	76.22	1.25
C-WD00-7236	1087	72	36	92.94	1.5	CT-WD00-7236	1308	72	36	92.94	1.5
C-WD00-7830	1145	78	30	82.7	1.35	CT-WD00-7830	1373	78	30	82.7	1.35
C-WD00-7836	1256	78	36	100.34	1.63	CT-WD00-7836	1511	78	36	100.34	1.63
C-WD00-8430	1204	84	30	89.18	1.46	CT-WD00-8430	1442	84	30	89.18	1.46
C-WD00-8436	1321	84	36	107.74	1.75	CT-WD00-8436	1587	84	36	107.74	1.75
1" Thick - With Grommet						1.5" Thick - Without Grommet					
C-WD0G-6030	799	60	30	63.27	1.04	CT-WD0G-6030	959	60	30	63.27	1.04
C-WD0G-6036	877	60	36	78.14	1.25	CT-WD0G-6036	1057	60	36	78.14	1.25
C-WD0G-6630	941	66	30	69.75	1.15	CT-WD0G-6630	1128	66	30	69.75	1.15
C-WD0G-6636	1037	66	36	85.54	1.38	CT-WD0G-6636	1238	66	36	85.54	1.38
C-WD0G-7230	1013	72	30	76.22	1.25	CT-WD0G-7230	1216	72	30	76.22	1.25
C-WD0G-7236	1114	72	36	92.94	1.5	CT-WD0G-7236	1331	72	36	92.94	1.5
C-WD0G-7830	1168	78	30	82.7	1.35	CT-WD0G-7830	1406	78	30	82.7	1.35
C-WD0G-7836	1280	78	36	100.34	1.63	CT-WD0G-7836	1536	78	36	100.34	1.63
C-WD0G-8430	1226	84	30	89.18	1.46	CT-WD0G-8430	1473	84	30	89.18	1.46
C-WD0G-8436	1349	84	36	107.74	1.75	CT-WD0G-8436	1617	84	36	107.74	1.75

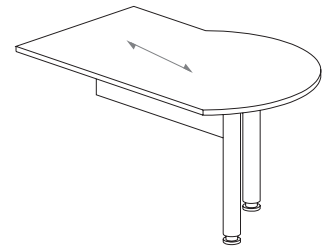

Right hand

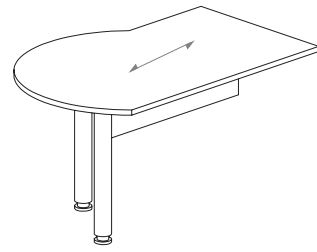

Left hand

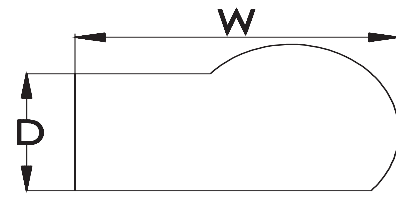

What's Included:

Panel-Mounted P-Table, 2 metal support posts, laminate partial modesty panel.

Notes:

Grain direction is indicated in the above illustration.

How To Specify:

Specify laminate color.

The panel-mounted P-table must be specified as left or right. The handed end has a bubble on the outside.

The worksurface trim color will default to match the laminate color unless otherwise specified, see the laminate finish card for details.

Edge profile must be specified for 1.5-inch thick worksurfaces. The color of the modesty panel will default to match the worksurface.

Options:

thickness	C 1-inch	CT 1.5-inch
width	60, 66, 72, 78, 84	
depth	30, 36	
hand	R right	L left
surface finish	laminate colors	
edge profile (1.5-inch only)	straight	
support finish	metal colors	

Code	Price	H (in)	W (in.)	Wt. (lb)	Vol. (ft ³)	Code	Price	H (in)	W (in.)	Wt. (lb)	Vol. (ft ³)
1" Thick - Without Grommet						1.5" Thick - Without Grommet					
C-WP00-6030-L	849	60	30	73.13	1.04	CT-WP00-6030-L	1021	60	30	73.13	1.04
C-WP00-6030-R	849	60	30	73.13	1.04	CT-WP00-6030-R	1021	60	30	73.13	1.04
C-WP00-6036-L	947	60	36	77	1.25	CT-WP00-6036-L	1140	60	36	77	1.25
C-WP00-6036-R	947	60	36	77	1.25	CT-WP00-6036-R	1140	60	36	77	1.25
C-WP00-6630-L	962	66	30	79.59	1.15	CT-WP00-6630-L	1156	66	30	79.59	1.15
C-WP00-6630-R	962	66	30	79.59	1.15	CT-WP00-6630-R	1156	66	30	79.59	1.15
C-WP00-6636-L	1061	66	36	83	1.38	CT-WP00-6636-L	1272	66	36	83	1.38
C-WP00-6636-R	1061	66	36	83	1.38	CT-WP00-6636-R	1272	66	36	83	1.38
C-WP00-7230-L	1027	72	30	86.07	1.25	CT-WP00-7230-L	1232	72	30	86.07	1.25
C-WP00-7230-R	1027	72	30	86.07	1.25	CT-WP00-7230-R	1232	72	30	86.07	1.25
C-WP00-7236-L	1120	72	36	90	1.5	CT-WP00-7236-L	1350	72	36	90	1.5
C-WP00-7236-R	1120	72	36	90	1.5	CT-WP00-7236-R	1350	72	36	90	1.5
C-WP00-7830-L	1204	78	30	92.55	1.35	CT-WP00-7830-L	1442	78	30	92.55	1.35
C-WP00-7830-R	1204	78	30	92.55	1.35	CT-WP00-7830-R	1442	78	30	92.55	1.35
C-WP00-7836-L	1297	78	36	96	1.63	CT-WP00-7836-L	1560	78	36	96	1.63
C-WP00-7836-R	1297	78	36	96	1.63	CT-WP00-7836-R	1560	78	36	96	1.63
C-WP00-8430-L	1295	84	30	99.02	1.46	CT-WP00-8430-L	1559	84	30	99.02	1.46
C-WP00-8430-R	1295	84	30	99.02	1.46	CT-WP00-8430-R	1559	84	30	99.02	1.46
C-WP00-8436-L	1419	84	36	103	1.75	CT-WP00-8436-L	1700	84	36	103	1.75
C-WP00-8436-R	1419	84	36	103	1.75	CT-WP00-8436-R	1700	84	36	103	1.75
1" Thick - With Grommet						1.5" Thick - With Grommet					
C-WP0G-6030-L	863	60	30	80	0.8	CT-WP0G-6030-L	1034	60	30	80	0.8
C-WP0G-6030-R	863	60	30	80	0.8	CT-WP0G-6030-R	1034	60	30	80	0.8
C-WP0G-6036-L	959	60	36	80	1	CT-WP0G-6036-L	1150	60	36	80	1
C-WP0G-6036-R	959	60	36	80	1	CT-WP0G-6036-R	1150	60	36	80	1
C-WP0G-6630-L	978	66	30	83	0.9	CT-WP0G-6630-L	1169	66	30	83	0.9
C-WP0G-6630-R	978	66	30	83	0.9	CT-WP0G-6630-R	1169	66	30	83	0.9
C-WP0G-6636-L	1075	66	36	83	1.2	CT-WP0G-6636-L	1290	66	36	83	1.2
C-WP0G-6636-R	1075	66	36	83	1.2	CT-WP0G-6636-R	1290	66	36	83	1.2
C-WP0G-7230-L	1040	72	30	86	1	CT-WP0G-7230-L	1247	72	30	86	1
C-WP0G-7230-R	1040	72	30	86	1	CT-WP0G-7230-R	1247	72	30	86	1
C-WP0G-7236-L	1140	72	36	86	1.3	CT-WP0G-7236-L	1361	72	36	86	1.3
C-WP0G-7236-R	1140	72	36	86	1.3	CT-WP0G-7236-R	1361	72	36	86	1.3
C-WP0G-7830-L	1219	78	30	89	1.1	CT-WP0G-7830-L	1460	78	30	89	1.1
C-WP0G-7830-R	1219	78	30	89	1.1	CT-WP0G-7830-R	1460	78	30	89	1.1
C-WP0G-7836-L	1315	78	36	89	1.4	CT-WP0G-7836-L	1573	78	36	89	1.4
C-WP0G-7836-R	1315	78	36	89	1.4	CT-WP0G-7836-R	1573	78	36	89	1.4
C-WP0G-8430-L	1312	84	30	99.02	1.46	CT-WP0G-8430-L	1572	84	30	99.02	1.46
C-WP0G-8430-R	1312	84	30	99.02	1.46	CT-WP0G-8430-R	1572	84	30	99.02	1.46
C-WP0G-8436-L	1432	84	36	103	1.75	CT-WP0G-8436-L	1713	84	36	103	1.75
C-WP0G-8436-R	1432	84	36	103	1.75	CT-WP0G-8436-R	1713	84	36	103	1.75

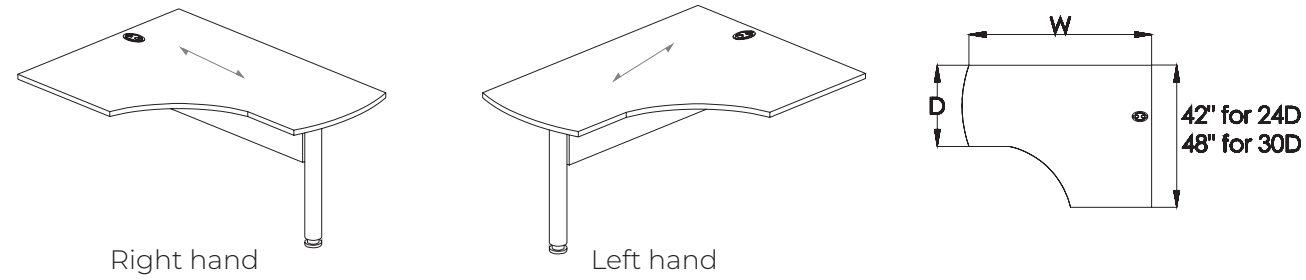

What's Included:

Panel-Mounted J-Table, grommet, metal support post, laminate partial modesty panel.

Notes:

Grain direction is indicated in the above illustration.

How To Specify:

Specify laminate color.

Specify metal color for support posts.

The panel-mounted J-table must be specified as left or right. The handed end is the longer side of the J-tab

The worksurface trim color will default to match the laminate color unless otherwise specified, see the laminate finish card for details.

Edge profile must be specified for 1.5-inch thick worksurfaces.

The color of the modesty will default to match the worksurface.

Keyboard tray can be mounted to this worksurface. Refer to the Accessories section [on page 166](#) for details.

Options:

thickness	C 1-inch	CT 1.5-inch
width	60, 66, 72, 78	
depth	24, 30	
hand	R right	L left
surface finish	laminate colors	
edge profile (1.5-inch only)	straight	
support finish	metal colors	

Code	Price	W (in.)	D 1 (in.)	Weight (lb)	Volume (ft ³)
1" Thick					
C-WJ0G-6024-L	1144	60	24	120	1.25
C-WJ0G-6024-R	1144	60	24	120	1.25
C-WJ0G-6030-L	1225	60	30	120	1.56
C-WJ0G-6030-R	1225	60	30	120	1.56
C-WJ0G-6624-L	1216	66	24	124.5	1.38
C-WJ0G-6624-R	1216	66	24	124.5	1.38
C-WJ0G-6630-L	1318	66	30	124.5	1.72
C-WJ0G-6630-R	1318	66	30	124.5	1.72
C-WJ0G-7224-L	1309	72	24	129	1.5
C-WJ0G-7224-R	1309	72	24	129	1.5
C-WJ0G-7230-L	1386	72	30	129	1.88
C-WJ0G-7230-R	1386	72	30	129	1.88
C-WJ0G-7824-L	1382	78	24	133.5	1.63
C-WJ0G-7824-R	1382	78	24	133.5	1.63
C-WJ0G-7830-L	1547	78	30	133.5	2.03
C-WJ0G-7830-R	1547	78	30	133.5	2.03
1.5" Thick					
CT-WJ0G-6024-L	1372	60	24	120	1.25
CT-WJ0G-6024-R	1372	60	24	120	1.25
CT-WJ0G-6030-L	1472	60	30	120	1.56
CT-WJ0G-6030-R	1472	60	30	120	1.56
CT-WJ0G-6624-L	1461	66	24	124.5	1.38
CT-WJ0G-6624-R	1461	66	24	124.5	1.38
CT-WJ0G-6630-L	1582	66	30	124.5	1.72
CT-WJ0G-6630-R	1582	66	30	124.5	1.72
CT-WJ0G-7224-L	1573	72	24	129	1.5
CT-WJ0G-7224-R	1573	72	24	129	1.5
CT-WJ0G-7230-L	1667	72	30	129	1.88
CT-WJ0G-7230-R	1667	72	30	129	1.88
CT-WJ0G-7824-L	1658	78	24	133.5	1.63
CT-WJ0G-7824-R	1658	78	24	133.5	1.63
CT-WJ0G-7830-L	1855	78	30	133.5	2.03
CT-WJ0G-7830-R	1855	78	30	133.5	2.03

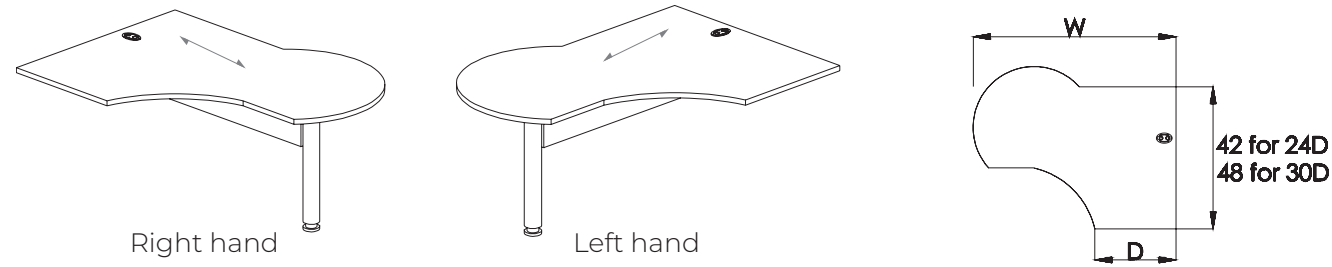

What's Included:

Panel-Mounted Y-Table, metal support posts, laminate partial modesty panel.

Notes:

Grain direction is indicated in the above illustration.

How To Specify:

Specify laminate color.

Specify metal color for support posts.

The panel-mounted Y-table must be specified as left or right. The handed end is rounded.

The worksurface trim color will default to match the laminate color unless otherwise specified, see the laminate finish card for details.

Edge profile must be specified for 1.5-inch thick worksurfaces.

The color of the modesty will default to match the worksurface.

Keyboard tray can be mounted to this worksurface. Refer to the Accessories section [on page 166](#) for details.

Options:

thickness	C 1-inch	CT 1.5-inch
width	60, 66, 72, 78	
depth	24, 30	
hand	R right	L left
surface finish	laminate colors	
edge profile (1.5-inch only)	straight	
support finish	metal colors	

Code	Price	W (in.)	D 1 (in.)	Weight (lb)	Volume (ft ³)
1" Thick					
C-WY0G-6024-L	1501	60	24	120	1.25
C-WY0G-6024-R	1501	60	24	120	1.25
C-WY0G-6624-L	1600	66	24	123	1.38
C-WY0G-6624-R	1600	66	24	123	1.38
C-WY0G-6630-L	1810	66	30	129	1.72
C-WY0G-6630-R	1810	66	30	129	1.72
C-WY0G-7224-L	1718	72	24	126	1.5
C-WY0G-7224-R	1718	72	24	126	1.5
C-WY0G-7230-L	1835	72	30	132	1.88
C-WY0G-7230-R	1835	72	30	132	1.88
C-WY0G-7824-L	1829	78	24	129	1.63
C-WY0G-7824-R	1829	78	24	129	1.63
C-WY0G-7830-L	1884	78	30	135	2.03
C-WY0G-7830-R	1884	78	30	135	2.03
C-WY0G-8430-L	1909	84	30	141	2.19
C-WY0G-8430-R	1909	84	30	141	2.19
1.5" Thick					
CT-WY0G-6024-L	1800	60	24	120	1.25
CT-WY0G-6024-R	1800	60	24	120	1.25
CT-WY0G-6624-L	1924	66	24	123	1.38
CT-WY0G-6624-R	1924	66	24	123	1.38
CT-WY0G-6630-L	2176	66	30	129	1.72
CT-WY0G-6630-R	2176	66	30	129	1.72
CT-WY0G-7224-L	2061	72	24	126	1.5
CT-WY0G-7224-R	2061	72	24	126	1.5
CT-WY0G-7230-L	2208	72	30	132	1.88
CT-WY0G-7230-R	2208	72	30	132	1.88
CT-WY0G-7824-L	2193	78	24	129	1.63
CT-WY0G-7824-R	2193	78	24	129	1.63
CT-WY0G-7830-L	2260	78	30	135	2.03
CT-WY0G-7830-R	2260	78	30	135	2.03
CT-WY0G-8430-L	2287	84	30	141	2.19
CT-WY0G-8430-R	2287	84	30	141	2.19

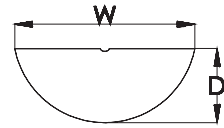
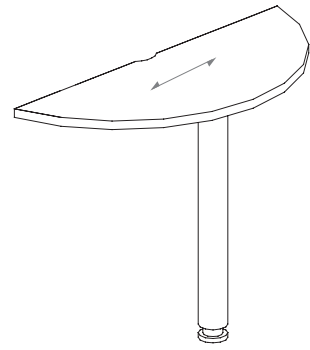

What's Included:

C-Table Extension, metal support post

Notes:

Grain direction is indicated in the above illustration.

How To Specify:

Specify laminate color.

Specify metal color for support posts.

The worksurface trim color will default to match the laminate color unless otherwise specified, see the laminate finish card for details.

Edge trim style must be specified for 1.5-inch thick worksurfaces.

Options:

thickness	C 1-inch	CT 1.5-inch
width	51, 63	
depth	16, 21, 26	
trim style	R radiused	S straight
surface finish	laminate colors	
edge profile (1.5-inch only)	straight	
support finish	metal colors	

Code	Price	W (in.)	D 1 (in.)	Weight (lb)	Volume (ft ³)
1" Thick					
C-WC00-5121-S	849	51	21	38.27	3.55
C-WC00-6326-S	912	63	26	54.56	5.41
1.5" Thick					
CT-WC00-5121-S	1014	51	21	38.27	3.55
CT-WC00-6326-S	1094	63	26	54.56	5.41

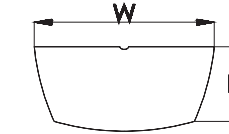
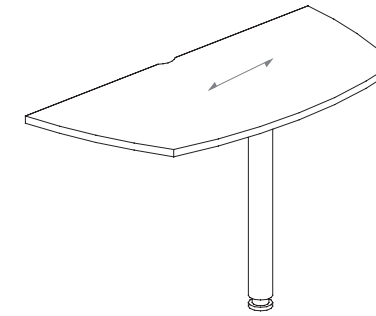

What's Included:

U-Table Extension, metal support post

Notes:

Grain direction is indicated in the above illustration.

How To Specify:

Specify laminate color.

Specify metal color for support posts.

The worksurface trim color will default to match the laminate color unless otherwise specified, see the laminate finish card for details.

Edge trim style must be specified for 1.5-inch thick worksurfaces.

Options:

thickness	C 1-inch	CT 1.5-inch
width	51, 63	
depth	18, 24, 28	
trim style	R radiused	S straight
surface finish	laminate colors	
edge profile (1.5-inch only)	straight	
support finish	metal colors	

Code	Price	W (in.)	D 1 (in.)	Weight (lb)	Volume (ft ³)
1" Thick					
C-WU00-3918	676	39	18	13.12	0.62
C-WU00-5124-S	897	51	24	17.14	0.81
C-WU00-6328-S	1030	63	28	21.17	1.02
1.5" Thick					
CT-WU00-3918	811	39	18	13.12	0.62
CT-WU00-5124-S	1074	51	24	17.14	0.81
CT-WU00-6328-S	1238	63	28	21.17	1.02

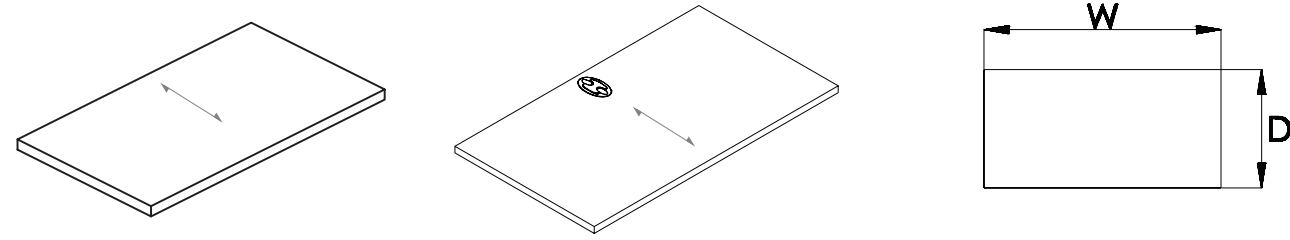

Without grommet

With grommet

What's Included:

Bridge Surface

Notes:

Grain direction is indicated in the above illustration.

How To Specify:

The worksurface trim color will default to match the laminate color unless otherwise specified, see the laminate finish card for details.

Edge profile must be specified for 1.5-inch thick worksurfaces.

Options:

thickness	C 1-inch	CT 1.5-inch
grommet	O without	G with grommet
width	24, 30, 36, 42, 48	
depth	18, 24, 30	
surface finish	laminate colors	
edge profile (1.5-inch only)	straight	

Code	Price	H (in)	W (in.)	Wt. (lb)	Vol. (ft ³)	Code	Price	H (in)	W (in.)	Wt. (lb)	Vol. (ft ³)
1" Thick - Without Grommet						1.5" Thick - Without Grommet					
C-BS00-2418	260	24	18	5.18	0.25	CT-BS00-2424	386	24	24	6.91	0.33
C-BS00-2424	282	24	24	6.91	0.33	CT-BS00-2430	412	24	30	8.64	0.42
C-BS00-2430	298	24	30	8.64	0.42	CT-BS00-3018	381	30	18	6.48	0.31
C-BS00-3018	281	30	18	6.48	0.31	CT-BS00-3024	412	30	24	8.64	0.42
C-BS00-3024	298	30	24	8.64	0.42	CT-BS00-3030	487	30	30	10.8	0.52
C-BS00-3030	357	30	30	10.8	0.52	CT-BS00-3618	400	36	18	7.78	0.38
C-BS00-3618	293	36	18	7.78	0.38	CT-BS00-3624	422	36	24	10.37	0.5
C-BS00-3624	307	36	24	10.37	0.5	CT-BS00-3630	514	36	30	12.96	0.63
C-BS00-3630	379	36	30	12.96	0.63	CT-BS00-4218	454	42	18	9.07	0.44
C-BS00-4218	333	42	18	9.07	0.44	CT-BS00-4224	500	42	24	12.1	0.58
C-BS00-4224	364	42	24	12.1	0.58	CT-BS00-4230	561	42	30	15.12	0.73
C-BS00-4230	412	42	30	15.12	0.73	CT-BS00-4818	478	48	18	10.37	0.5
C-BS00-4818	350	48	18	10.37	0.5	CT-BS00-4824	536	48	24	13.82	0.67
C-BS00-4824	396	48	24	13.82	0.67	CT-BS00-4830	607	48	30	17.28	0.83
C-BS00-4830	449	48	30	17.28	0.83						
1" Thick - With Grommet						1.5" Thick - With Grommet					
C-BS0G-2418	275	24	18	5.18	0.25	CT-BS0G-2418	370	24	18	5.18	0.25
C-BS0G-2424	296	24	24	6.91	0.33	CT-BS0G-2424	401	24	24	6.91	0.33
C-BS0G-2430	316	24	30	8.64	0.42	CT-BS0G-2430	426	24	30	8.64	0.42
C-BS0G-3018	295	30	18	6.48	0.31	CT-BS0G-3018	395	30	18	6.48	0.31
C-BS0G-3024	316	30	24	8.64	0.42	CT-BS0G-3024	426	30	24	8.64	0.42
C-BS0G-3030	370	30	30	10.8	0.52	CT-BS0G-3030	500	30	30	10.8	0.52
C-BS0G-3618	305	36	18	7.78	0.38	CT-BS0G-3618	414	36	18	7.78	0.38
C-BS0G-3624	324	36	24	10.37	0.5	CT-BS0G-3624	438	36	24	10.37	0.5
C-BS0G-3630	389	36	30	12.96	0.63	CT-BS0G-3630	531	36	30	12.96	0.63
C-BS0G-4218	348	42	18	9.07	0.44	CT-BS0G-4218	470	42	18	9.07	0.44
C-BS0G-4224	381	42	24	12.1	0.58	CT-BS0G-4224	512	42	24	12.1	0.58
C-BS0G-4230	426	42	30	15.12	0.73	CT-BS0G-4230	573	42	30	15.12	0.73
C-BS0G-4818	364	48	18	10.37	0.5	CT-BS0G-4818	496	48	18	10.37	0.5
C-BS0G-4824	409	48	24	13.82	0.67	CT-BS0G-4824	550	48	24	13.82	0.67
C-BS0G-4830	459	48	30	17.28	0.83	CT-BS0G-4830	620	48	30	17.28	0.83



What's Included:

Radiused Extended Surface

Notes:

Grain direction is indicated in the above illustration.

How To Specify:

Specify laminate color.

Specify metal color for support posts.

The worksurface trim color will default to match the laminate color unless otherwise specified, see the laminate finish card for details.

Edge trim style must be specified for 1.5-inch thick worksurfaces.

Options:

thickness	C 1-inch	CT 1.5-inch
width	27, 33	
depth	27, 33	
surface finish	laminate colors	
edge profile (1.5-inch only)	straight	

Code	Price	W (in.)	D 1 (in.)	Weight (lb)	Volume (ft ³)
1" thick					
C-WC01-2727	348	27	27	13.81	0.33
C-WC01-3333	421	33	33	14.3	0.49
1.5 " thick					
CT-WC01-2727	470	27	27	13.81	0.33
CT-WC01-3333	572	33	33	14.3	0.49

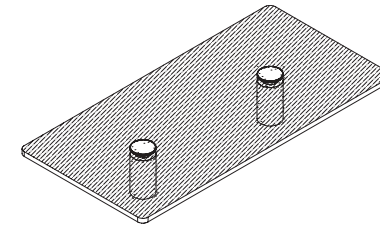

What's Included:

Tempered Glass transaction top, installation hardware, two post legs.

Notes:

The tempered glass transaction top can be mounted on top of one or two 37-inch high panel frames to provide a transaction surface for a reception station or between two workstations in a team environment.

The tempered glass transaction top is not applicable on 90, 120, or 135-degree configurations.

Options:

width	24, 30, 36, 42, 48, 54,
depth	12
metal finish	metal colors

How To Specify:

Specify metal finish.

When the tempered glass transaction top is to be mounted over a single panel frame, specify the transaction top to be the same width as the panel frame. When it is to be mounted over two panel frames, specify the transaction top to be the total width of the two panel frames.

Code	Price	W (in.)	D 1 (in.)	Weight (lb)	Volume (ft ³)
C-WTGS-2412	925	24	12	5	0.2
C-WTGS-3012	997	30	12	6	0.2
C-WTGS-3612	1060	36	12	7	0.3
C-WTGS-4212	1119	42	12	8	0.3
C-WTGS-4812	1187	48	12	9	0.3
C-WTGS-5412	1247	54	12	10	0.3

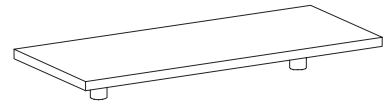

What's Included:

Laminate countertop, installation hardware, two post legs.

Notes:

How To Specify:

Specify laminate color.
Specify metal finish.

When the laminate countertop is to be mounted over a single panel frame, specify the countertop to be the same width as the panel frame. When it is to be mounted over two panel frames, specify the countertop to be the total width of the two panel frames.

Options:

width	24, 30, 36, 42, 48, 54, 60			
depth	15			
configuration	A 90-degree	B 120-degree	C 135-degree	O 180-degree
end shape	S - straight right 90-degree corner right 120-degree corner right 135-degree corner	left 90-degree corner left 120-degree corner left 135-degree corner	dual 90-degree corner dual 120-degree corner dual 135-degree corner	
surface finish	laminate colors			
metal finish	metal colors			

Code	Price	H (in)	W (in.)	Wt. (lb)	Vol. (ft ³)	Code	Price	H (in)	W (in.)	Wt. (lb)	Vol. (ft ³)
1" Thick						1.5" Thick - 180-degree countertop					
C-WTL0-2415	510	24	15	4.32	0.21	CT-WTL0-2415	561	24	15	4.32	0.21
C-WTL0-3015	547	30	15	5.4	0.26	CT-WTL0-3015	613	30	15	5.4	0.26
C-WTL0-3615	578	36	15	6.48	0.31	CT-WTL0-3615	654	36	15	6.48	0.31
C-WTL0-4215	589	42	15	7.56	0.36	CT-WTL0-4215	671	42	15	7.56	0.36
C-WTL0-4815	641	48	15	8.64	0.42	CT-WTL0-4815	741	48	15	8.64	0.42
C-WTL0-5415	666	54	15	9.72	0.47	CT-WTL0-5415	778	54	15	9.72	0.47
C-WTL0-6015	689	60	15	10.8	0.52	CT-WTL0-6015	813	60	15	10.8	0.52

Code	Price	H (in)	W (in.)	Wt. (lb)	Vol. (ft ³)	Code	Price	H (in)	W (in.)	Wt. (lb)	Vol. (ft ³)
1" Thick - 90-degree corner (single)						1.5" Thick - 90-degree corner (single)					
C-WTLA-2415-L	580	24	15	4.32	0.21	CT-WTLA-2415-L	651	24	15	4.32	0.21
C-WTLA-2415-R	580	24	15	4.32	0.21	CT-WTLA-2415-R	651	24	15	4.32	0.21
C-WTLA-3015-L	620	30	15	4.32	0.26	CT-WTLA-3015-L	703	30	15	4.32	0.26
C-WTLA-3015-R	620	30	15	4.32	0.26	CT-WTLA-3015-R	703	30	15	4.32	0.26
C-WTLA-3615-L	644	36	15	6.48	0.31	CT-WTLA-3615-L	726	36	15	6.48	0.31
C-WTLA-3615-R	644	36	15	6.48	0.31	CT-WTLA-3615-R	726	36	15	6.48	0.31
C-WTLA-4215-L	669	42	15	7.56	0.36	CT-WTLA-4215-L	741	42	15	7.56	0.36
C-WTLA-4215-R	669	42	15	7.56	0.36	CT-WTLA-4215-R	741	42	15	7.56	0.36
C-WTLA-4815-L	708	48	15	8.64	0.42	CT-WTLA-4815-L	782	48	15	8.64	0.42
C-WTLA-4815-R	708	48	15	8.64	0.42	CT-WTLA-4815-R	782	48	15	8.64	0.42
C-WTLA-5415-L	739	54	15	9.72	0.47	CT-WTLA-5415-L	812	54	15	9.72	0.47
C-WTLA-5415-R	739	54	15	9.72	0.47	CT-WTLA-5415-R	812	54	15	9.72	0.47
C-WTLA-6015-L	773	60	15	10.8	0.52	CT-WTLA-6015-L	844	60	15	10.8	0.52
C-WTLA-6015-R	773	60	15	10.8	0.52	CT-WTLA-6015-R	844	60	15	10.8	0.52

Code	Price	H (in)	W (in.)	Wt. (lb)	Vol. (ft ³)	Code	Price	H (in)	W (in.)	Wt. (lb)	Vol. (ft ³)
1" Thick - 90-degree corner (dual)						1.5" Thick - 90-degree corner (dual)					
C-WTLA-2415	651	24	15	4.32	0.21	CT-WTLA-2415	736	24	15	4.32	0.21
C-WTLA-3015	703	30	15	4.32	0.26	CT-WTLA-3015	800	30	15	4.32	0.26
C-WTLA-3615	726	36	15	6.48	0.31	CT-WTLA-3615	838	36	15	6.48	0.31
C-WTLA-4215	741	42	15	7.56	0.36	CT-WTLA-4215	858	42	15	7.56	0.36
C-WTLA-4815	782	48	15	8.64	0.42	CT-WTLA-4815	919	48	15	8.64	0.42
C-WTLA-5415	812	54	15	9.72	0.47	CT-WTLA-5415	959	54	15	9.72	0.47
C-WTLA-6015	844	60	15	10.8	0.52	CT-WTLA-6015	1005	60	15	10.8	0.52

Code	Price	H (in)	W (in.)	Wt. (lb)	Vol. (ft³)	Code	Price	H (in)	W (in.)	Wt. (lb)	Vol. (ft³)
1" Thick - 120-degree corner (single)						1.5" Thick - 120-degree corner (single)					
C-WTLB-2415-L	567	24	15	4.32	0.21	CT-WTLB-2415-L	628	24	15	4.32	0.21
C-WTLB-2415-R	567	24	15	4.32	0.21	CT-WTLB-2415-R	628	24	15	4.32	0.21
C-WTLB-3015-L	607	30	15	5.4	0.26	CT-WTLB-3015-L	681	30	15	5.4	0.26
C-WTLB-3015-R	607	30	15	5.4	0.26	CT-WTLB-3015-R	681	30	15	5.4	0.26
C-WTLB-3615-L	630	36	15	6.48	0.31	CT-WTLB-3615-L	716	36	15	6.48	0.31
C-WTLB-3615-R	630	36	15	6.48	0.31	CT-WTLB-3615-R	716	36	15	6.48	0.31
C-WTLB-4215-L	639	42	15	7.56	0.36	CT-WTLB-4215-L	735	42	15	7.56	0.36
C-WTLB-4215-R	639	42	15	7.56	0.36	CT-WTLB-4215-R	735	42	15	7.56	0.36
C-WTLB-4815-L	692	48	15	8.64	0.42	CT-WTLB-4815-L	800	48	15	8.64	0.42
C-WTLB-4815-R	692	48	15	8.64	0.42	CT-WTLB-4815-R	800	48	15	8.64	0.42
C-WTLB-5415-L	718	54	15	9.72	0.47	CT-WTLB-5415-L	837	54	15	9.72	0.47
C-WTLB-5415-R	718	54	15	9.72	0.47	CT-WTLB-5415-R	837	54	15	9.72	0.47
C-WTLB-6015-L	746	60	15	10.8	0.52	CT-WTLB-6015-L	882	60	15	10.8	0.52
C-WTLB-6015-R	746	60	15	10.8	0.52	CT-WTLB-6015-R	882	60	15	10.8	0.52

Code	Price	H (in)	W (in.)	Wt. (lb)	Vol. (ft³)	Code	Price	H (in)	W (in.)	Wt. (lb)	Vol. (ft³)
1" Thick - 120-degree corner (dual)						1.5" Thick - 120-degree corner (dual)					
C-WTLB-2415	618	24	15	4.32	0.21	CT-WTLB-2415	687	24	15	4.32	0.21
C-WTLB-3015	655	30	15	5.4	0.26	CT-WTLB-3015	742	30	15	5.4	0.26
C-WTLB-3615	683	36	15	6.48	0.31	CT-WTLB-3615	778	36	15	6.48	0.31
C-WTLB-4215	706	42	15	7.56	0.36	CT-WTLB-4215	806	42	15	7.56	0.36
C-WTLB-4815	742	48	15	8.64	0.42	CT-WTLB-4815	863	48	15	8.64	0.42
C-WTLB-5415	778	54	15	9.72	0.47	CT-WTLB-5415	906	54	15	9.72	0.47
C-WTLB-6015	806	60	15	10.8	0.52	CT-WTLB-6015	952	60	15	10.8	0.52

Code	Price	H (in)	W (in.)	Wt. (lb)	Vol. (ft³)	Code	Price	H (in)	W (in.)	Wt. (lb)	Vol. (ft³)
1" Thick - 135-degree corner (single)						1.5" Thick - 135-degree corner (single)					
C-WTLC-2415-L	563	24	15	4.32	0.21	CT-WTLC-2415-L	618	24	15	4.32	0.21
C-WTLC-2415-R	563	24	15	4.32	0.21	CT-WTLC-2415-R	618	24	15	4.32	0.21
C-WTLC-3015-L	590	30	15	5.4	0.26	CT-WTLC-3015-L	665	30	15	5.4	0.26
C-WTLC-3015-R	590	30	15	5.4	0.26	CT-WTLC-3015-R	665	30	15	5.4	0.26
C-WTLC-3615-L	625	36	15	6.48	0.31	CT-WTLC-3615-L	708	36	15	6.48	0.31
C-WTLC-3615-R	625	36	15	6.48	0.31	CT-WTLC-3615-R	708	36	15	6.48	0.31
C-WTLC-4215-L	633	42	15	7.56	0.36	CT-WTLC-4215-L	725	42	15	7.56	0.36
C-WTLC-4215-R	633	42	15	7.56	0.36	CT-WTLC-4215-R	725	42	15	7.56	0.36
C-WTLC-4815-L	688	48	15	8.64	0.42	CT-WTLC-4815-L	793	48	15	8.64	0.42
C-WTLC-4815-R	688	48	15	8.64	0.42	CT-WTLC-4815-R	793	48	15	8.64	0.42
C-WTLC-5415-L	712	54	15	9.72	0.47	CT-WTLC-5415-L	871	54	15	9.72	0.47
C-WTLC-5415-R	712	54	15	9.72	0.47	CT-WTLC-5415-R	871	54	15	9.72	0.47
C-WTLC-6015-L	741	60	15	10.8	0.52	CT-WTLC-6015-L	882	60	15	10.8	0.52
C-WTLC-6015-R	741	60	15	10.8	0.52	CT-WTLC-6015-R	882	60	15	10.8	0.52

Code	Price	H (in)	W (in.)	Wt. (lb)	Vol. (ft³)	Code	Price	H (in)	W (in.)	Wt. (lb)	Vol. (ft³)
1" Thick - 135-degree corner (dual)						1.5" Thick - 135-degree corner (dual)					
C-WTLC-2415	607	24	15	4.32	0.21	CT-WTLC-2415	667	24	15	4.32	0.21
C-WTLC-3015	644	30	15	5.4	0.26	CT-WTLC-3015	721	30	15	5.4	0.26
C-WTLC-3615	668	36	15	6.48	0.31	CT-WTLC-3615	758	36	15	6.48	0.31
C-WTLC-4215	692	42	15	7.56	0.36	CT-WTLC-4215	725	42	15	7.56	0.36
C-WTLC-4815	731	48	15	8.64	0.42	CT-WTLC-4815	846	48	15	8.64	0.42
C-WTLC-5415	760	54	15	9.72	0.47	CT-WTLC-5415	894	54	15	9.72	0.47
C-WTLC-6015	788	60	15	10.8	0.52	CT-WTLC-6015	924	60	15	10.8	0.52



Cosmo Pricebook
August 2024

Worksurface Supports

worksurface supports

cantilever arm	118
universal bracket	119
single post	120
horizontal surface support	121
laminated gable	122
intermediate gable	123
open metal gable	124

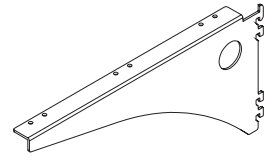

What's Included:

Cantilever Arm, installation hardware.

How to Specify:

Cantilever arms are available only in black.

Options:

size	16, 22	
position	R right	L left

Notes:

The cantilever arm mounts to the panel frame to support worksurfaces.

Worksurfaces 24 inches and greater require the 22-inch cantilever to be used.

How to Order and Read your Code:

C	CCAB	16	L
product line	item	width	position

Code	Price	D 1 (in.)	Weight (lb)	Volume (ft ³)
C-CCAB-16	105	16	2.2	0.01
C-CCAB-16-L	105	16	2.2	0.01
C-CCAB-16-R	105	16	2.2	0.01
C-CCAB-22	113	22	2.7	0.01
C-CCAB-22-L	113	22	2.7	0.01
C-CCAB-22-R	113	22	2.7	0.01

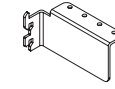

right hand

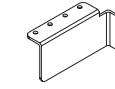

left hand

What's Included:

Universal Bracket, installation hardware.

How to Specify:

Specify right or left hand according to the position of the worksurface.

The universal bracket is available only in black.

Options:

hand	R right	L left
------	----------------	---------------

Notes:

The universal bracket is primarily used for end or side corner support and must be used in conjunction with other primary supports, such as gables, cantilever arms, or single posts.

Code	Price	Weight (lb)	Volume (ft ³)
C-CB01-L	8	1	0.01
C-CB01-R	8	1	0.01

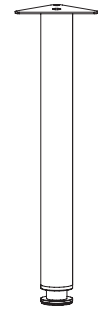

What's Included:

Single Post, leveler, installation hardware.

How to Specify:

Specify metal finish. See the metal finish card for details.

Options:

finish metal finish colors

Notes:

The single post is 28-inch in height and includes an integral leveler that provides a 3-inch levelling range.

This item should be used together with panel-mounted worksurface supports to support semi-suspended worksurfaces.

Code	Price	H (in.)	Weight (lb)	Volume (ft ³)
C-CP1G-03	149	28	7	0.11

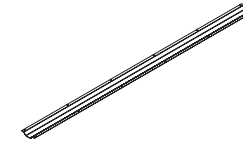

What's Included:

Horizontal Surface Support, installation hardware.

How to Specify:

The horizontal surface support is available only in silver.

Options:

width 51, 57, 63, 69, 75

Notes:

The horizontal surface support is used to support worksurfaces 54-inches and longer.

This item is mounted to the underside of a worksurface.

Code	Price	W (in)	Weight (lb)	Volume (ft ³)
C-CH00-54	71	51	4	0.05
C-CH00-60	77	57	4.5	0.05
C-CH00-66	82	63	5	0.06
C-CH00-72	86	69	5.5	0.06
C-CH00-78	91	75	6	0.07

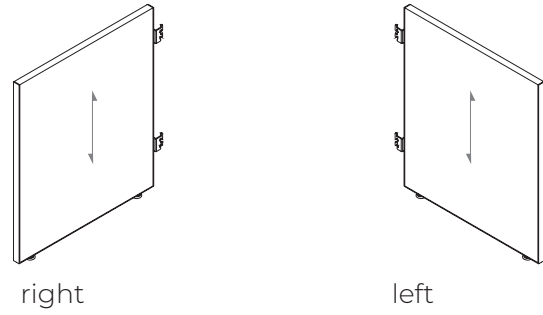

What's Included:

Gable, installation hardware.

How to Specify:

Specify laminate color.

The vinyl trim color will default to match the laminate color unless otherwise specified. See the laminate finish card for details.

Options:

position	R right	L left	U - universal
depth	12, 18, 24, 30, 36		

Notes:

Grain direction is indicated in the above illustration.

Gables can be used for single or dual worksurface support in the left, right and center positions.

The left and right gables are designed to match the depth of standard worksurfaces. The center gable will be slightly shorter than the depth of the worksurface to allow for below worksurface leg room.

Code	Price	H (in.)	D 1 (in.)	Weight (lb)	Volume (ft ³)
C-CGL0-12	127	12	7.5	0.01	0.01
C-CGR0-12	127	12	7.5	0.01	0.01
C-CGL0-18	152	18	11.47	0.01	0.01
C-CGR0-18	152	18	11.47	0.01	0.01
C-CGL0-24	174	24	15.4	0.01	0.01
C-CGR0-24	174	24	15.4	0.01	0.01
C-CGL0-30	202	30	19.32	0.01	0.01
C-CGR0-30	202	30	19.32	0.01	0.01
C-CGL0-36	220	36	19.35	0.01	0.01
C-CGR0-36	220	36	19.35	0.01	0.01
C-CGU0-12	127	12	7.5	0.01	0.01
C-CGU0-18	152	18	11.47	0.01	0.01
C-CGU0-24	174	24	15.4	0.01	0.01
C-CGU0-30	202	30	19.32	0.01	0.01
C-CGU0-36	220	36	19.35	0.01	0.01

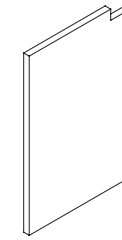

What's Included:

Gable, installation hardware.

How to Specify:

Specify laminate color.

The vinyl trim color will default to match the laminate color unless otherwise specified. See the laminate finish card for details.

Options:

position	R right	L right	U - universal
depth	12, 18, 24		
finish	laminate colors		

Notes:

Grain direction is indicated in the above illustration.

Gables can be used for single or dual worksurface support in the left, right and center positions.

The left and right gables are designed to match the depth of standard worksurfaces. The center gable will be slightly shorter than the depth of the worksurface to allow for below worksurface leg room.

Code	Price	H (in.)	D 1 (in.)	Weight (lb)	Volume (ft ³)
C-CGLC-12	127	28	12	7.5	0.01
C-CGRC-12	127	28	12	7.5	0.01
C-CGLC-18	152	28	18	11.47	0.01
C-CGRC-18	152	28	18	11.47	0.01
C-CGUC-12	127	28	12	7.5	0.01
C-CGUC-18	152	28	18	11.47	0.01
C-CGUC-24	174	28	24	16.5	0.01

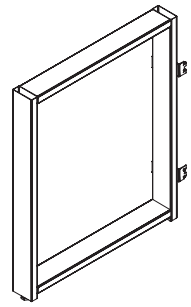

right hand

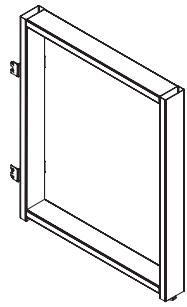

left hand

What's Included:

Open metal gable, installation hardware.

How to Specify:

Specify metal color.

Notes:

Open metal gables can be used to support worksurfaces in the left or right position.

The depth of the open metal gable should match the depth of the worksurface that it will support at the end of a run.

Use the 12 or 18-inch pen metal gable to support worksurface in the middle of a run.

Open metal gables cannot be used in freestanding applications

Options:

position	R right	L left
size	12, 18, 24, 30	
finish	metal colors	

Code	Price	H (in.)	D 1 (in.)	Weight (lb)	Volume (ft ³)
Left Hand					
C-CGLM-12	487	28	12	6	0.58
C-CGLM-18	512	28	18	10	0.88
C-CGLM-24	548	28	24	14	1.17
C-CGLM-30	581	28	30	14	1.17
Right Hand					
C-CGRM-12	487	28	12	6	0.58
C-CGRM-18	512	28	18	10	0.88
C-CGRM-24	548	28	24	14	1.17
C-CGRM-30	581	28	30	14	1.17



Cosmo Pricebook
August 2024
Mounted Storage

mounted storage

<u>panel-mounted flipper cabinet</u>	128
<u>suspended flipper cabinet</u>	130
<u>wall mounted flipper cabinet</u>	132
<u>top mounted shared open shelf</u>	134
<u>cubby storage</u>	136
<u>open metal shelf</u>	137
<u>overhead back bracket</u>	138
<u>double channel wall mount bracket kit</u>	139

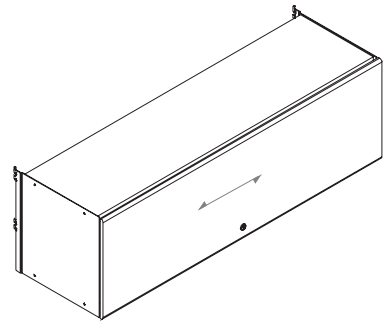

flipper cabinet

What's Included:

Panel-Mounted Flipper Cabinet, installation hardware.

How to Specify:

Specify metal color.

Specify laminate color (for laminate faced flipper only).

Specify option P for pneumatic slides.

The vinyl trim color will default to match the laminate color unless otherwise specified. See the laminate finish card for details.

Notes:

Grain direction is indicated in the above illustration.

The panel-mounted flipper cabinet mounts on-module to panel frames of the same width.

The optional pneumatic slide allows the flipper door to come down slowly and quietly.

Options:

depth	14	
width	30, 36, 42, 48, 54, 60	
door finish	L laminate colors	M metal colors
enhancements	P pneumatic*	
case finish	metal colors	

* an upcharge is applicable when this option is specified

How to Order and Read your Code:

C	SOF	M	14	30	P
product line	item	door finish	depth	width	enhancements

Standard	Price	H (in.)	W (in.)	D 1 (in.)	Weight (lb)	Volume (ft3)
Pneumatic Laminate						
C-SOFL-1430-P	1129	16	30	14	32.1	2.92
C-SOFL-1436-P	1189	16	36	14	34.7	3.5
C-SOFL-1442-P	1232	16	42	14	38.6	4.08
C-SOFL-1448-P	1270	16	48	14	42.5	4.67
C-SOFL-1454-P	1290	16	54	14	45.7	5.25
C-SOFL-1460-P	1355	16	60	14	49.1	5.83
Pneumatic Metal						
C-SOFM-1430-P	1203	16	30	14	32.1	2.92
C-SOFM-1436-P	1270	16	36	14	34.7	3.5
C-SOFM-1442-P	1322	16	42	14	38.6	4.08
C-SOFM-1448-P	1361	16	48	14	42.5	4.67
C-SOFM-1454-P	1379	16	54	14	45.7	5.25
C-SOFM-1460-P	1456	16	60	14	49.1	5.83

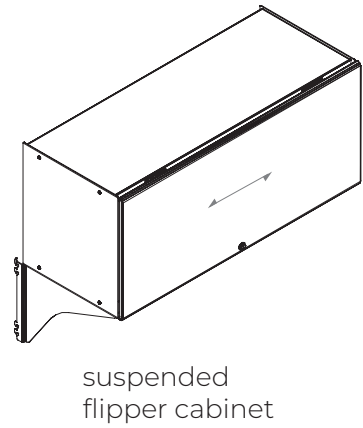

What's Included:

Suspended flipper cabinet, installation hardware.

How to Specify:

Specify metal color.

Specify laminate color (for laminate faced flipper only).

Specify option P for pneumatic slides.

The vinyl trim color will default to match the laminate color unless otherwise specified. See the laminate finish card for details.

Options:

depth	14
width	30, 36, 42, 48, 54, 60
door finish	L laminate colors M metal colors
enhancements	P pneumatic*
case finish	metal colors

* an upcharge is applicable when this option is specified

Code	Price	H (in.)	W (in.)	D1 (in.)	Weight (lb)	Volume (ft ³)
Standard Metal						
C-SSFM-1430	1026	16	30	14	32.1	2.92
C-SSFM-1436	1087	16	36	14	34.7	3.5
C-SSFM-1442	1144	16	42	14	38.6	4.08
C-SSFM-1448	1181	16	48	14	42.5	4.67
C-SSFM-1454	1226	16	54	14	45.7	5.25
C-SSFM-1460	1268	16	60	14	49.1	5.83
Pneumatic Laminate						
C-SSFL-1430-P	1326	16	30	14	32.1	2.1
C-SSFL-1436-P	1380	16	36	14	34.7	3.5
C-SSFL-1442-P	1427	16	42	14	38.6	4.1
C-SSFL-1448-P	1459	16	48	14	42.5	4.7
C-SSFL-1454-P	1472	16	54	14	45.7	5.3
C-SSFL-1460-P	1537	16	60	14	49.1	5.8
Pneumatic Metal						
C-SSFM-1430-P	1386	16	30	14	32.1	2.92
C-SSFM-1436-P	1458	16	36	14	34.7	3.5
C-SSFM-1442-P	1511	16	42	14	38.6	4.08
C-SSFM-1448-P	1542	16	48	14	42.5	4.67
C-SSFM-1454-P	1557	16	54	14	45.7	5.25
C-SSFM-1460-P	1636	16	60	14	49.1	5.83

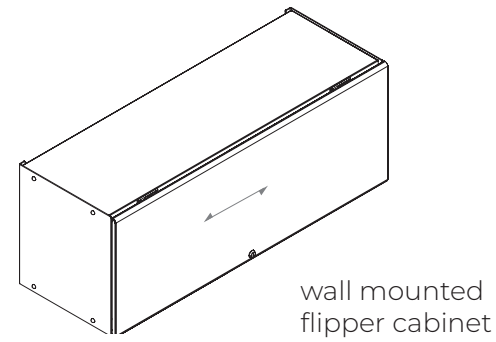

What's Included:

Wall mounted flipper cabinet, installation hardware.

How to Specify:

- Specify metal color.
- Specify laminate color (for laminate faced flipper only).
- Specify wall mounting hardware separately
- Specify option P for pneumatic slides.
- The vinyl trim color will default to match the laminate color unless otherwise specified.

Notes:

- Grain direction is indicated in the above illustration.
- The wall-mounted flipper cabinet mounts off-module to walls to provide overhead storage in a workstation.
- The optional pneumatic slide allows the flipper door to come down slowly and quietly.

Options:

depth	14
width	30, 36, 42, 48, 54, 60
door finish	L laminate colors M metal colors
enhancements	P pneumatic*
case finish	metal colors

* an upcharge is applicable when this option is specified

Code	Price	H (in.)	W (in.)	D1 (in.)	Weight (lb)	Volume (ft ³)
Pneumatic Laminate						
C-SOFL-1430-P-W	1129	16	30	14	32.1	2.92
C-SOFL-1436-P-W	1189	16	36	14	34.7	3.5
C-SOFL-1442-P-W	1232	16	42	14	38.6	4.08
C-SOFL-1448-P-W	1270	16	48	14	42.5	4.67
C-SOFL-1454-P-W	1290	16	54	14	45.7	5.25
C-SOFL-1460-P-W	1355	16	60	14	49.1	5.83
Pneumatic Metal						
C-SOFM-1430-P-W	1203	16	30	14	32.1	2.92
C-SOFM-1436-P-W	1270	16	36	14	34.7	3.5
C-SOFM-1442-P-W	1322	16	42	14	38.6	4.08
C-SOFM-1448-P-W	1361	16	48	14	42.5	4.67
C-SOFM-1454-P-W	1379	16	54	14	45.7	5.25
C-SOFM-1460-P-W	1456	16	60	14	49.1	5.83

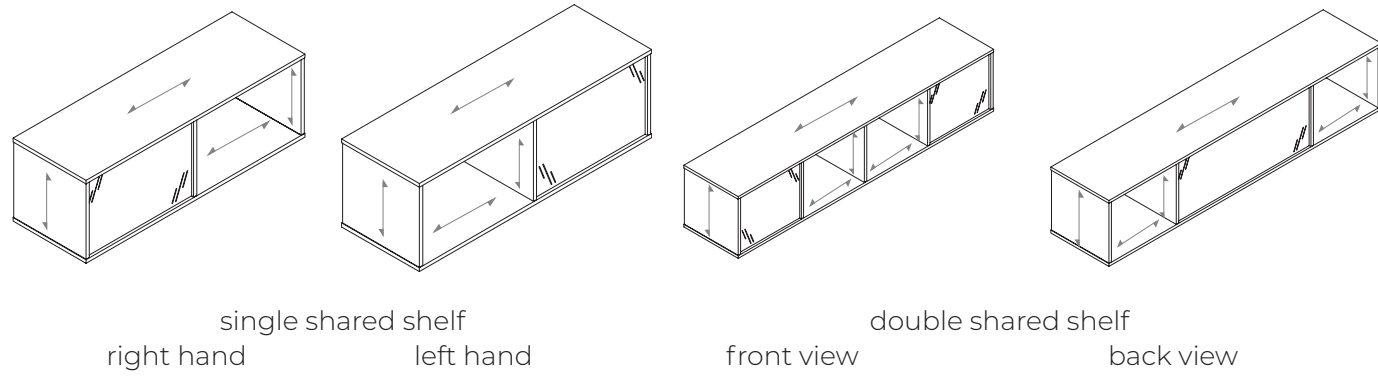

What's Included:

Top mounted shared open shelf, installation hardware

How to Specify:

Specify laminate color.

Specify back option.

Notes:

Grain direction is indicated in the above illustration.

The top mounted shared shelf mounts on top of a panel frame and provides open storage to two workstations.

The back of the top mounted shared shelf can be finished in acrylic or whiteboard.

The single unit can be used on top of one or two panel frames.

The double units is used over two or more panel frames where a 3-way or 4-way 90 degree connector is also present, as illustrated above

Options:

back finish	G acrylic	W whiteboard
width	24, 30, 36, 42, 48, 54, 60	
depth	16	
height	16	
hand	L left	R right
case finish	laminate colors	

Code	Price	H (in.)	W (in.)	D 1 (in.)	Weight (lb)	Volume (ft ³)
Single Shared Shelves						
C-SSOG-30-L	932	16	30	16	35	2.5
C-SSOG-36-L	1014	16	36	16	38	3
C-SSOG-42-L	1102	16	42	16	41	3.5
C-SSOG-48-L	1188	16	48	16	44	4
C-SSOG-54-L	1271	16	54	16	47	4.5
C-SSOG-60-L	1357	16	60	16	50	5
C-SSOG-72-L	1525	16	72	16	56	6
C-SSOG-84-L	1693	16	84	16	62	7
C-SSOG-30-R	932	16	30	16	35	2.5
C-SSOG-36-R	1014	16	36	16	38	3
C-SSOG-42-R	1102	16	42	16	41	3.5
C-SSOG-48-R	1188	16	48	16	44	4
C-SSOG-54-R	1271	16	54	16	47	4.5
C-SSOG-60-R	1357	16	60	16	50	5
C-SSOG-72-R	1525	16	72	16	56	6
C-SSOG-84-R	1693	16	84	16	62	7
Double Shared Shelves						
C-SSOW-24-L	796	16	30	16	35	2.5
C-SSOW-30-L	837	16	30	16	35	2.5
C-SSOW-36-L	898	16	36	16	38	3
C-SSOW-42-L	954	16	42	16	41	3.5
C-SSOW-48-L	1013	16	48	16	44	4
C-SSOW-54-L	1075	16	54	16	47	4.5
C-SSOW-60-L	1135	16	60	16	50	5
C-SSOW-72-L	1252	16	72	16	56	6
C-SSOW-84-L	1372	16	84	16	62	7
C-SSOW-24-R	796	16	30	16	35	2.5
C-SSOW-30-R	837	16	30	16	35	2.5
C-SSOW-36-R	898	16	36	16	38	3
C-SSOW-42-R	954	16	42	16	41	3.5
C-SSOW-48-R	1013	16	48	16	44	4
C-SSOW-54-R	1075	16	54	16	47	4.5
C-SSOW-60-R	1135	16	60	16	50	5
C-SSOW-72-R	1252	16	72	16	56	6
C-SSOW-84-R	1372	16	84	16	62	7

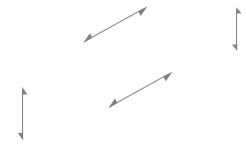

cubby storage

What's Included:

Cubby storage, installation hardware.

Notes:

The panel-mounted cubby storage mounts on-module to panel frames of the same width.

Options:

depth	11
width	24, 30, 36, 42, 48
height	8
finish	L laminate colors
hardware finish	M metal colors

How to Specify:

Grain direction is indicated in the above illustration.

Specify laminate color.

Specify hardware finish.

The vinyl trim color will default to match the laminate color unless otherwise specified. See the laminate finish card for details

Code	Price	H (in.)	W (in.)	D 1 (in.)	Weight (lb)	Volume (ft ³)
C-SCS-081124	316	8	24	11	N/A	1.3
C-SCS-081130	337	8	30	11	N/A	1.7
C-SCS-081136	361	8	36	11	N/A	2
C-SCS-081142	385	8	42	11	N/A	2.3
C-SCS-081148	439	8	48	11	N/A	2.7

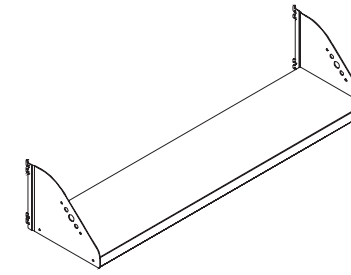

open metal shelf

What's Included:

Open Metal Shelf, installation hardware

How to Specify:

Specify metal color.

Options:

width	24, 30, 36, 42, 48, 54, 60
case finish	metal colors

Notes:

The open metal shelf is panel-mounted on-module, and provides open storage within the workstation.

Code	Price	W (in.)	D 1 (in.)	Weight (lb)	Volume (ft ³)
C-SOOM-1224	217	24	12	13.03	1
C-SOOM-1230	228	30	12	13.03	1.25
C-SOOM-1236	242	36	12	14.74	1.5
C-SOOM-1242	252	42	12	16.48	1.75
C-SOOM-1248	260	48	12	18.2	2
C-SOOM-1254	271	54	12	19.93	2.25
C-SOOM-1260	281	60	12	21.65	2.5

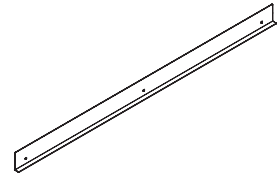

What's Included:

Overhead Back Bracket, installation hardware

How to Specify:

Specify metal color.

Options:

width 24, 30, 36, 42, 48, 54, 60
 case finish metal colors

Code	Price	W (in.)	Weight (lb)	Volume (ft ³)
C-SOBB-24	35	24	1	0.01
C-SOBB-30	38	30	1	0.02
C-SOBB-36	43	36	1.2	0.02
C-SOBB-42	48	42	1.4	0.02
C-SOBB-48	50	48	1.6	0.03
C-SOBB-54	55	54	1.8	0.03
C-SOBB-60	58	60	2	0.03

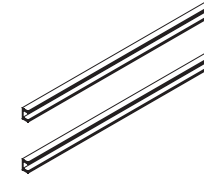

What's Included:

Double channel wall mount bracket kit

How to Specify:

Options:

width 24, 30, 36, 42, 48, 54, 60
 case finish metal colors

Code	Price	W (in.)	Weight (lb)	Volume (ft ³)
C-ADWB-24-KIT	116	23.5	2	0.03
C-ADWB-30-KIT	143	29.5	4	0.04
C-ADWB-36-KIT	175	35.5	6	0.05
C-ADWB-42-KIT	209	41.5	8	0.05
C-ADWB-48-KIT	237	47.5	10	0.06
C-ADWB-54-KIT	266	53.5	12	0.07
C-ADWB-60-KIT	296	59.5	14	0.08



Cosmo Pricebook
August 2024

Freestanding Storage

freestanding storage

mobile pedestal	142
mobile pedestal with seat	143
freestanding pedestal	144
freestanding joined pedestal	145
freestanding lateral file	146
freestanding lateral file	147
closed storage tower	148
open storage tower with wardrobe	149
closed storage tower with closet	150
file/file/file storage tower	151
single door storage cabinet	152
double door storage tower	154
combination cabinet	155

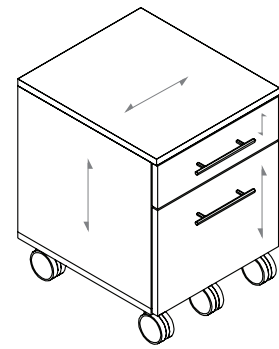

box file

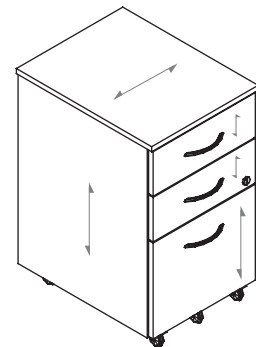

box/box file

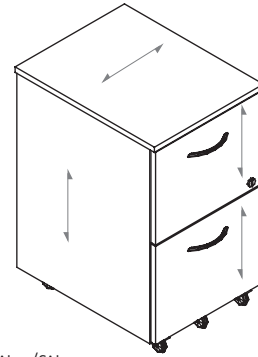

file/file

What's Included:

One mobile pedestal, lock and key, pencil tray.

How to Specify:

Refer to the laminate finish card for a complete listing of laminate colors.

The edge trim style will default to match the finish of the pedestal unless otherwise specified. Refer to the laminate finish card for details.

Options:

height	21.5, 28
width	16, 17
case and drawer finish	laminate colors

Notes:

The mobile pedestal is 21-inches deep and is equipped with castors for easy mobility.

The Manhattan handle style is offered on mobile pedestals.

Grain direction is indicated in the above illustration.

How to Order and Read your Code:

C **1000** **28** **16** **L112**
 product line item height width case & drawer finish

Code	Price	H (in.)	W (in.)	D 1 (in.)	Weight (lb)	Volume (ft ³)
box file						
C-1000-2317	1201	21.5	16	18	75	4.75
box/box file						
C-FPBM-1621	1072	28	16	21	60	5.64
file/file						
C-FPFM-1621	951	28	16	21	60	5.64

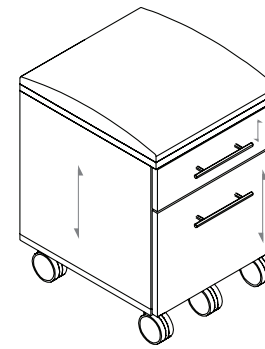

mobile pedestal with seat

What's Included:

One mobile pedestal with seat, lock and key, pencil tray.

How to Specify:

Refer to the laminate finish card for a complete listing of laminate colors.

The edge trim style will default to match the finish of the pedestal unless otherwise specified. Refer to the laminate finish card for details.

Notes:

The mobile pedestal with seat is 21-inches deep and is equipped with castors for easy mobility.

The Manhattan handle style is offered on mobile pedestals.

Grain direction is indicated in the above illustration.

Options:

height	23
width	17
case and drawer finish	laminate colors
seating upholstery	seating fabrics

Code	Price	H (in.)	W (in.)	D 1 (in.)	Weight (lb)	Volume (ft ³)
C-1030-2317	1251	23	17	23	75	4.75

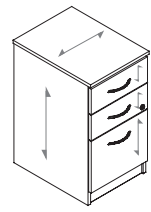

box/box/file

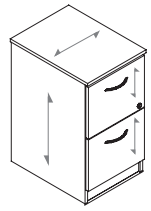

file/file

What's Included:

Freestanding Pedestal, lock and keys.

How to Specify:

Specify laminate color.

Specify handle style.

Handles default to Melbourne, unless otherwise specified.

The vinyl trim color will default to match the laminate color unless otherwise specified. See the laminate finish card for details.

Notes:

Pedestals are 21-inches deep.

The box/box/file freestanding pedestal includes a pencil tray

Grain direction is indicated in the above illustration..

Options:

type	B box/box/file	F file/file
width	16	
depth	21	
case finish	laminate colors	
handle style	brooklyn melbourne clifton humber manhattan rosedale	

Code	Price	H (in.)	W (in.)	D 1 (in.)	Weight (lb)	Volume (ft ³)
box/box/file						
C-FPBF-1621	1059	29	16	21	67.2	5.64
file/file						
C-FPFF-1621	934	29	16	21	67.2	5.64

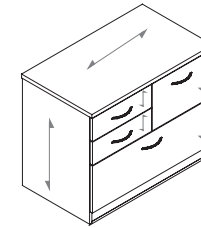

What's Included:

Freestanding Joined Pedestal, lock and keys.

How to Specify:

Specify laminate color.

Specify handle style.

Handles default to Melbourne, unless otherwise specified.

The vinyl trim color will default to match the laminate color unless otherwise specified. See the laminate finish card for details.

Notes:

Freestanding joined pedestals are 21-inches deep.

The freestanding joined pedestal includes a pencil tray.

Grain direction is indicated in the above illustration..

Options:

width	36
depth	21
case finish	laminate colors

Code	Price	H (in.)	W (in.)	D 1 (in.)	Weight (lb)	Volume (ft ³)
C-FPJF-3621	1835	29	36	21	130	12.69

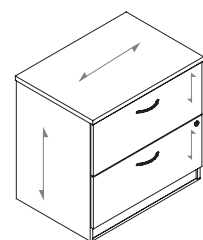

2 drawer

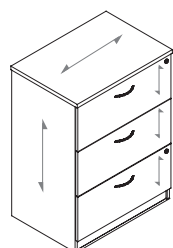

3 drawer

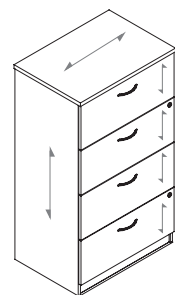

4 drawer

What's Included:

Freestanding Lateral File, lock and keys.

How to Specify:

Specify laminate color.

Specify handle style.

Handles default to Melbourne, unless otherwise specified.

The vinyl trim color will default to match the laminate color unless otherwise specified. See the laminate finish card for details.

Notes:

Laterals are 21-inches deep.

Grain direction is indicated in the above illustration..

Disclaimer: Please note that lateral file drawers are intended for filing letter and legal size paper front to back or side to side only. For details and weight restrictions please contact customer service.

Options:

type	2 two-drawer	3 three-drawer	4 four-drawer
width	30, 36, 42		
depth	21		
case finish	laminate colors		
handle style	brooklyn	melbourne	clifton humber manhattan rosdale

Code	Price	H (in.)	W (in.)	D 1 (in.)	Weight (lb)	Volume (ft ³)
2 Drawer						
C-FL2F-3021	1478	29	30	21	107	10.57
C-FL2F-3621	1566	29	36	21	130	12.69
C-FL2F-4221	1643	29	42	21	150	14.8
3 Drawer						
C-FL3F-3021	2021	40.5	30	21	167	14.77
C-FL3F-3621	2142	40.5	36	21	180	17.72
4 Drawer						
C-FL4F-3021	2538	52.5	30	21	200	19.14
C-FL4F-3621	2688	52.5	36	21	240	22.97

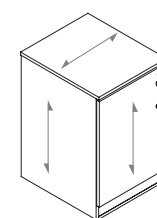

single door

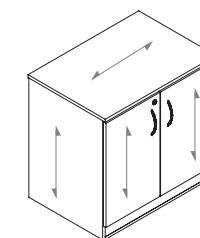

double door

What's Included:

Freestanding Storage Cabinet, lock and keys.

How to Specify:

Specify laminate color.

Specify handle style.

The vinyl trim color will default to match the laminate color unless otherwise specified. See the laminate finish card for details.

Notes:

Storage cabinets are 21-inches deep.

Grain direction is indicated in the above illustration..

Options:

width	18, 30, 36
hand (for single cabinet door only)	R right L left
case finish	laminate colors
handle style	brooklyn melbourne clifton humber manhattan rosdale

Code	Price	H (in.)	W (in.)	D 1 (in.)	Weight (lb)	Volume (ft ³)
Single door						
C-FSF0-1821-L	849	29	18	21	80	6.34
C-FSF0-1821-R	849	29	18	21	80	6.34
Double Door						
C-FSF0-3021	1163	29	30	21	107	7.4
C-FSF0-3621	1240	29	36	21	130	7.4

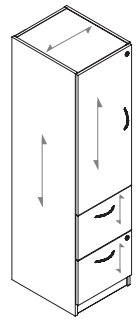

lamine file/file



lamine box/box file

What's Included:

Closed Storage Tower, shelves, lock and keys, levelers.

How to Specify:

Specify laminate color.

Specify handle style.

Handles default to Melbourne, unless otherwise specified.

The vinyl trim color will default to match the laminate color unless otherwise specified. See the laminate finish card for details.

Notes:

Shelves are adjustable in 1-inch increments.

Grain direction is indicated in the above illustration..

Options:

type	00 box/box/file	10 file/file
height	66	
width	18	
depth	21	
hand	R right	L left
case finish	lamine colors	
handle style	brooklyn	melbourne clifton humber manhattan rosdale

Code	Price	H (in.)	W (in.)	D 1 (in.)	Weight (lb)	Volume (ft ³)
C-7010-6618-L	1884	66	18	21	180	13.64
C-7010-6618-R	1884	66	18	21	180	13.64
C-7000-6618-L	1989	66	18	21	180	13.64
C-7000-6618-R	1989	66	18	21	180	13.64

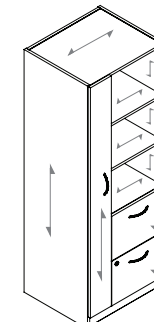

file/file

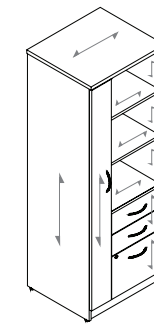

box/box file

What's Included:

Storage Tower with Wardrobe, shelves, lock and keys, levelers.

How to Specify:

Specify laminate color.

Specify handle style.

Handles default to Melbourne, unless otherwise specified.

The vinyl trim color will default to match the laminate color unless otherwise specified. See the laminate finish card for details.

Notes:

Shelves are adjustable in 1-inch increments.

Cabinets are 21-inches deep.

Options:

type	30 box/box/file	40 file/file
height	66	
width	24	
depth	21	
hand	R right	L left
case finish	lamine colors	
handle style	brooklyn	melbourne clifton humber manhattan rosdale

Code	Price	H (in.)	W (in.)	D 1 (in.)	Weight (lb)	Volume (ft ³)
file/file						
C-8040-6624-L	2183	66	24	21	190	19.25
C-8040-6624-R	2183	66	24	21	190	19.25
box/box/file						
C-8030-6624-L	2284	66	24	21	190	19.25
C-8030-6624-R	2284	66	24	21	190	19.25

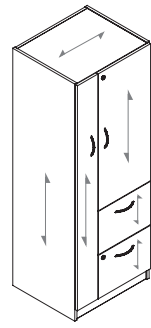

file/file

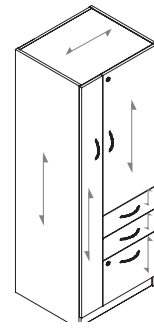

box/box file

What's Included:

Closed Storage Tower with Closet, shelves, coat rod, lock and keys, levelers.

How to Specify:

Specify laminate color.

Specify handle style.

Handles default to Melbourne, unless otherwise specified.

The vinyl trim color will default to match the laminate color unless otherwise specified. See the laminate finish card for details.

Notes:

Shelves are adjustable in 1-inch increments.

Grain direction is indicated in the above illustration..

Cabinets are 21-inches deep.

Options:

type	00 box/box/file	10 file/file
height	66	
width	24	
depth	21	
hand	R right	L left
case finish	laminate colors	
handle style	brooklyn	melbourne clifton humber manhattan rosedale

Code	Price	H (in.)	W (in.)	D 1 (in.)	Weight (lb)	Volume (ft ³)
C-6010-6624-L	2436	66	24	21	195	19.25
C-6010-6624-R	2436	66	24	21	195	19.25
C-6000-6624-L	2543	66	24	21	195	19.25
C-6000-6624-R	2543	66	24	21	195	19.25

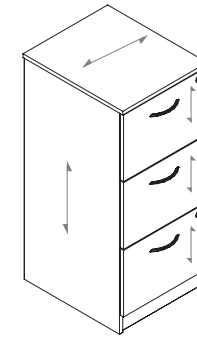

What's Included:

File/File/File Storage Tower, lock and keys.

How to Specify:

Specify laminate color.

Specify handle style.

Handles default to Melbourne, unless otherwise specified.

The vinyl trim color will default to match the laminate color unless otherwise specified. See the laminate finish card for details.

Notes:

Towers are 21-inches deep.

Grain direction is indicated in the above illustration..

Options:

height	42					
width	18					
depth	21					
case finish	laminate colors					
handle style	brooklyn	melbourne	clifton	humber	manhattan	rosedale

Code	Price	H (in.)	W (in.)	D 1 (in.)	Weight (lb)	Volume (ft ³)
C-3000-4218	1421	42	18	21	120	8.68

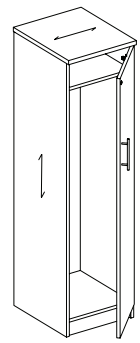

with coat bar right hand

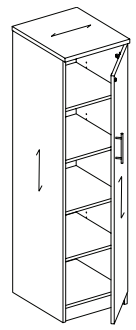

with shelves right hand

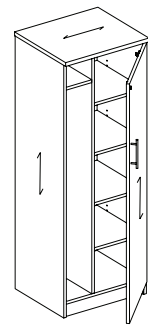

with coat bar and shelves right hand

What's Included:

Single Door Storage Cabinet, shelves and/or coat bar, lock and keys, levelers

How to Specify:

Specify laminate color.

Specify handle style.

Handles default to Melbourne, unless otherwise specified.

The vinyl trim color will default to match the laminate color unless otherwise specified. See the laminate finish card for details.

Notes:

One shelf is fixed at worksurface height, while the other shelves are adjustable in 1 inch increments.

Cabinets are 21 or 24 inches deep.

Grain direction is indicated in the above illustration.

Options:

height	66
width	18, 24
depth	21, 24
hand	R right L left
case finish	laminate colors
handle style	brooklyn melbourne clifton humber manhattan rosedale

Code	Price	H (in.)	W (in.)	D 1 (in.)	Weight (lb)	Volume (ft ³)
C-FSDB-1821-L	1271	66	18	21	140	14.44
C-FSDB-1821-R	1271	66	18	21	140	14.44
C-FSDS-1821-L	1512	66	18	21	160	13.74
C-FSDS-1821-R	1512	66	18	21	160	13.74
C-FSDC-2421-L	1804	66	24	21	150	19.25
C-FSDC-2421-R	1804	66	24	21	150	19.25
Acrylic						
C-FSDB-1821-L-G	2170	66	18	21	140	14.44
C-FSDB-1821-R-G	2170	66	18	21	140	14.44

freestanding storage | double door storage tower

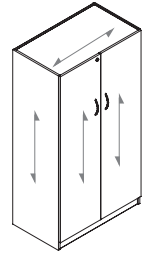

double laminate door with shelves

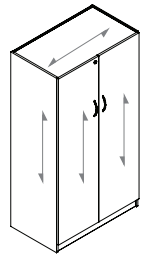

double laminate door with coat bar

What's Included:

Double Door Storage Cabinet, shelves or coat rod, lock and keys, levelers.

How to Specify:

Specify laminate color.

Specify handle style.

Handles default to Melbourne, unless otherwise specified.

The vinyl trim color will default to match the laminate color unless otherwise specified. See the laminate finish card for details.

Notes:

One shelf is fixed at worksurface height, while the other shelves are adjustable in 1-inch increments.

Cabinets are 21-inches deep.

Grain direction is indicated in the above illustration..

Options:

height	66
width	36
depth	21
case finish	laminate colors
case finish	laminate colors
handle style	brooklyn melbourne clifton humber manhattan rosdale

Code	Price	H (in.)	W (in.)	D 1 (in.)	Weight (lb)	Volume (ft ³)
C-FSDB-3621	1969	66	36	21	195	28.88
C-FSDS-3621	2190	66	36	21	195	29.09
Acrylic						
C-FSDB-3621-G	3676	66	36	21	195	29.09
C-FSDS-3621-G	4048	66	36	21	195	29.09

combination cabinet | freestanding storage

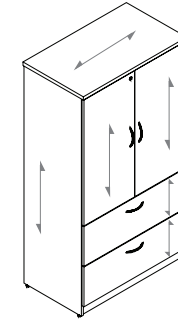

Laminate Combination Cabinet

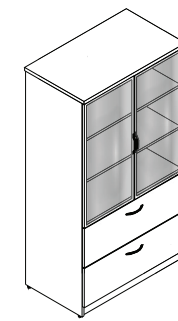

Laminate Combination Cabinet with Acrylic Doors

What's Included:

Combination Cabinet, shelves, lock and keys, levelers.

How to Specify:

Specify laminate color.

Specify handle style.

Handles default to Melbourne, unless otherwise specified.

The vinyl trim color will default to match the laminate color unless otherwise specified. See the laminate finish card for details.

Options:

configuration	L lateral file
height	66
width	30, 36
depth	21
case finish	laminate colors
handle style	brooklyn melbourne clifton humber manhattan rosdale

Notes:

Shelves are adjustable in 1-inch increments.

Cabinets are 21-inches deep.

Grain direction is indicated in the above illustration..

Disclaimer: Please note that lateral file drawers are intended for filing letter and legal size paper front to back or side to side only. For details and weight restrictions please contact customer service.

Code	Price	H (in.)	W (in.)	D 1 (in.)	Weight (lb)	Volume (ft ³)
C-FCSL-3021	2711	66	30	21	220	24.24
C-FCSL-3621	2895	66	36	21	240	29.09
Acrylic						
C-FCSL-3021-G	3933	66	30	21	220	24.24
C-FCSL-3621-G	4192	66	36	21	240	29.09



Cosmo Pricebook
August 2024
Storage

storage

<u>end gable pedestal</u>	158
<u>underdesk pedestal</u>	159
<u>underworksurface open shelf</u>	160
<u>underdesk joined pedestal</u>	161
<u>underdesk lateral file</u>	162
<u>underdesk storage cabinet</u>	163

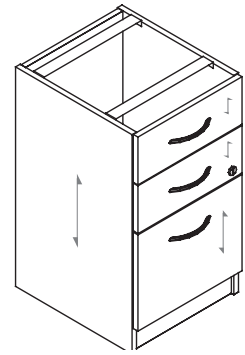

box/box/file

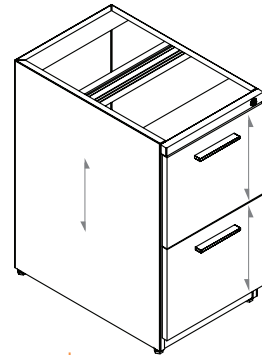

file/file

What's Included:

End Gable Pedestal, lock and keys.

How to Specify:

Refer to the laminate finish card for a complete listing of laminate colors.

The edge trim style will default to match the finish of the pedestal unless otherwise specified. Refer to the laminate finish card for details.

Options:

type	B box/box/file	F file/file
width	16	
depth	24, 30	
hand	R right	L left
handle style	brooklyn melbourne	clifton humber manhattan rosedale
case finish	laminate colors	

How to Order and Read your Code:

C	FPBU	16	24	R or L
product line	item	width	depth	hand

Code	Price	H (in.)	W (in.)	D 1 (in.)	Weight (lb)	Volume (ft ³)
C-FPBU-1618	922	28	16	18	58	4.67
C-FPFU-1618	816	28	16	18	56.5	4.67
C-FPBU-1624-L	1003	28	16	24	58	6.22
C-FPBU-1624-R	1003	28	16	24	58	6.22
C-FPBU-1630-L	1060	28	16	30	71	5.2
C-FPBU-1630-R	1060	28	16	30	71	5.2
C-FPFU-1624-L	900	28	16	24	58	6.22
C-FPFU-1624-R	900	28	16	24	58	6.22

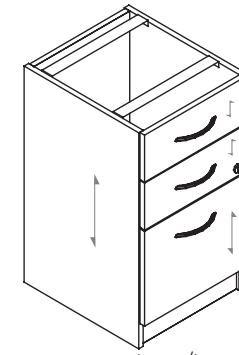

box/box/file

What's Included:

Underdesk Pedestal, lock and keys.

How to Specify:

Specify laminate color.

Specify handle style.

Handles default to Melbourne, unless otherwise specified.

The vinyl trim color will default to match the laminate color unless otherwise specified. See the laminate finish card for details.

Notes:

Pedestals are 18-inches deep.

The box/box/file freestanding pedestal includes a pencil tray.

Grain direction is indicated in the above illustration.

Options:

height	28					
width	16					
case and drawer finish	laminate colors					
handle style	brooklyn	melbourne	clifton	humber	manhattan	rosedale

Code	Price	H (in.)	W (in.)	D 1 (in.)	Weight (lb)	Volume (ft ³)
C-FPBU-1618	922	28	16	18	58	4.67
C-FPFU-1618	816	28	16	18	56.5	4.67

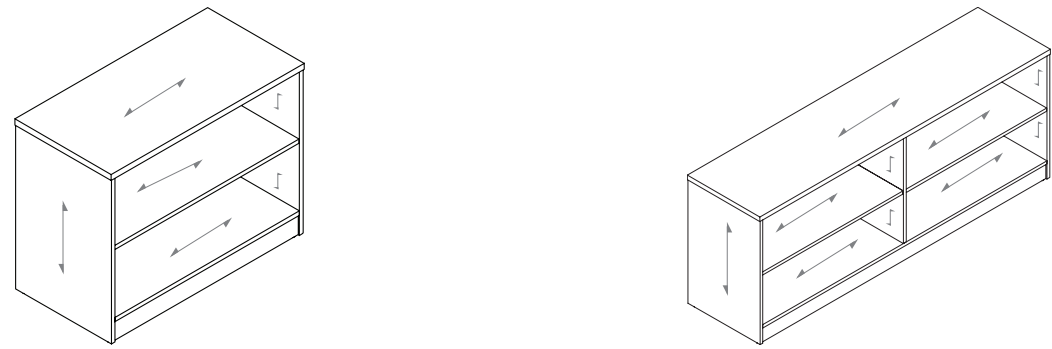

What's Included:

Underworksurface open shelf, installation hardware.

How to Specify:

Specify laminate color.

Options:

width	24, 30, 36, 42, 48, 54, 60, 66, 72, 78, 84, 90, 96
depth	18
height	28
case finish	laminate colors

Notes:

The underworksurface open shelf supports worksurfaces and provides below worksurface storage.

Grain direction is indicated in the above illustration.

Code	Price	H (in.)	W (in.)	D 1 (in.)	Weight (lb)	Volume (ft ³)
C-FSOU-2418	713	28	24	18	20	7.2
C-FSOU-3018	773	28	30	18	24	9
C-FSOU-3618	831	28	36	18	28	10.8
C-FSOU-4218	886	28	42	18	32	12.6
C-FSOU-4818	947	28	48	18	36	14.4
C-FSOU-5418	1225	28	54	18	40	16.2
C-FSOU-6018	1286	28	60	18	44	18
C-FSOU-6618	1349	28	66	18	48	19.8
C-FSOU-7218	1408	28	72	18	52	21.6
C-FSOU-7818	1473	28	78	18	56	23.4
C-FSOU-8418	1534	28	84	18	60	25.2
C-FSOU-9018	1594	28	90	18	64	27
C-FSOU-9618	1654	28	96	18	68	28.8

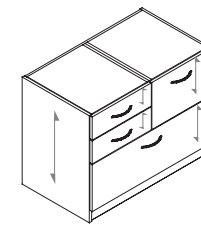

What's Included:

Underdesk Joined Pedestal, lock and keys..

How to Specify:

Specify laminate color.

Specify handle style.

Handles default to Melbourne, unless otherwise specified.

The vinyl trim color will default to match the laminate color unless otherwise specified. See the laminate finish card for details.

Notes:

Underdesk joined pedestals are 21-inches deep.

The underdesk joined pedestal includes a pencil tray.

Grain direction is indicated in the above illustration.

Options:

width	36
depth	21
case and drawer finish	laminate colors
handle style	brooklyn melbourne clifton humber manhattan rosdale

Code	Price	H (in.)	W (in.)	D 1 (in.)	Weight (lb)	Volume (ft ³)
C-FPJU-3621	1800	28	36	21	130	12.69

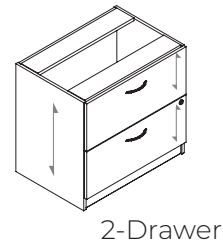

2-Drawer

What's Included:

Underdesk Lateral File, lock and keys.

How to Specify:

Refer to the laminate finish card for a complete listing of laminate colors.

The edge trim style will default to match the finish of the pedestal unless otherwise specified. Refer to the laminate finish card for details.

Notes:

Laterals are 21-inches deep.

Grain direction is indicated in the above illustration.

Disclaimer: Please note that lateral file drawers are intended for filing letter and legal size paper front to back or side to side only. For details and weight restrictions please contact customer service.

Options:

width	30, 36, 42					
depth	21					
case finish	laminate colors					
handle style	brooklyn	melbourne	clifton	humber	manhattan	rosedale

Code	Price	H (in.)	W (in.)	D 1 (in.)	Weight (lb)	Volume (ft ³)
C-FL2U-3021	1431	28	30	21	107	10.21
C-FL2U-3621	1507	28	36	21	130	12.25
C-FL2U-4221	1582	28	42	21	150	14.29

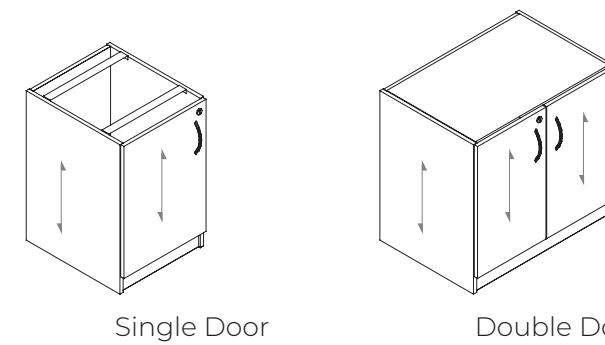

Single Door

Double Door

What's Included:

Underdesk Storage Cabinet, lock and keys.

How to Specify:

Refer to the laminate finish card for a complete listing of laminate colors.

The edge trim style will default to match the finish of the pedestal unless otherwise specified. Refer to the laminate finish card for details.

Notes:

Storage cabinets are 21-inches deep.

Grain direction is indicated in the above illustration.

Options:

width	18, 30, 36					
depth	21					
hand (for single door cabinet only)	R right					L left
case finish	laminate colors					
handle style	brooklyn	melbourne	clifton	humber	manhattan	rosedale

Code	Price	H (in.)	W (in.)	D 1 (in.)	Weight (lb)	Volume (ft ³)
C-FSU0-1821-L	826	28	18	21	80	6.13
C-FSU0-1821-R	826	28	18	21	80	6.13
C-FSU0-3021	1135	28	30	21	107	10.21
C-FSU0-3621	1207	28	36	21	130	12.25



Cosmo Pricebook
August 2024
Accessories

accessories

work organizers	166
accessory bar	167
pencil tray	168
coat hook	169
keyboard tray	170
monitor arm	171
top trim mounted privacy screen	172
wall mounted tackboard	174
worksurface edge mounted screen	178
panel mounted privacy screen	180

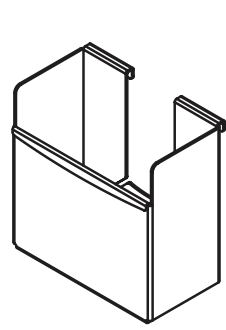

pen holder

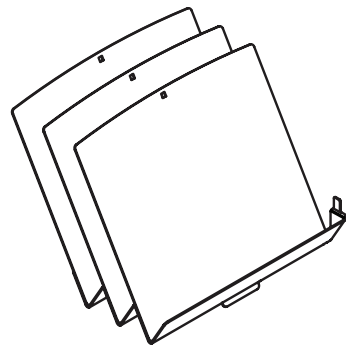

paper sorter

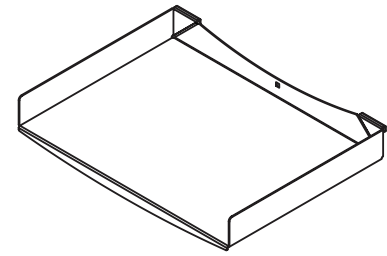

paper tray

What's Included:

One work organizer, as specified.

How to Specify:

Work organizers are available in a variety of metal finish colors.

Refer to the metal accent and metal finish card for a complete listing of metal colors.

Options:

accessory type	S paper sorter H pen holder	P 9 paper tray (letter)	P 13 paper tray (legal)
finish	metal colors (except chrome)		

Notes:

Work organizers hang from accessory tile, accessory bar, and surface mounted work organizer support.

Paper trays are available in letter and legal sizes.

Code	Price	H (in.)	W (in.)	Weight (lb)	Volume (ft ³)
paper sorter					
C-AAS	189	11	10	3	3.2
paper tray (letter)					
C-AAP-9	93	2	12	9	3.2
paper tray (legal)					
C-AAP-13	107	2	15	9	3.2
pen holder					
C-AAH	84	4	4	2	1.13

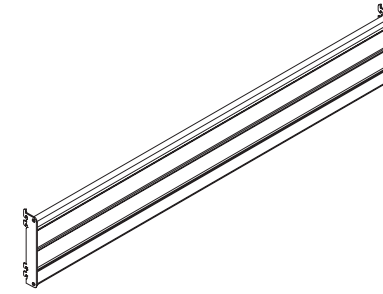

What's Included:

Accessory Bar.

How to Specify:

Specify metal color.

Options:

width	18, 24, 30, 36, 42, 48, 54, 60
finish	metal colors

Notes:

Accessory bars are installed over panel tiles in 1-inch increments.

Code	Price	H (in.)	W (in.)	Weight (lb)	Volume (ft ³)
C-AAB0-18	139	8	18	1.7	0.04
C-AAB0-24	163	8	24	1.7	0.06
C-AAB0-30	189	8	30	1.9	0.07
C-AAB0-36	213	8	36	2.3	0.08
C-AAB0-42	240	8	42	2.7	0.1
C-AAB0-48	264	8	48	2.9	0.11
C-AAB0-54	286	8	54	3.2	0.13
C-AAB0-60	311	8	60	3.5	0.14

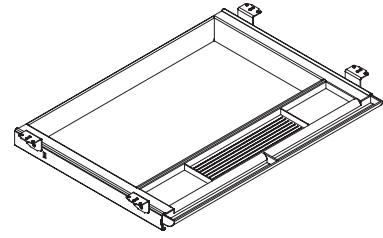

What's Included:

Pencil Drawer, installation hardware, mounting slides.

How to Specify:

This product is available only in black.

Options:

There are no options for this product.

Notes:

Pencil drawers provide compartmentalized pencil and stationary storage below the worksurface.

Code	Price	W (in.)	Weight (lb)	Volume (ft ³)
V-ADPP	88	21	2	0.62

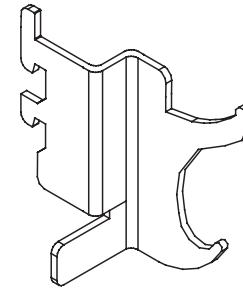

What's Included:

One work organizer, as specified.

How to Specify:

Specify metal color.

Options:

finish metal colors

Notes:

The coat hook can be attached to the hingeway between cosmopolitan panel frames.

Code	Price	Weight (lb)	Volume (ft ³)
C-ACH0	82	1	0.01

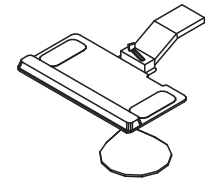

Articulating Keyboard Tray w/Mouse Tray

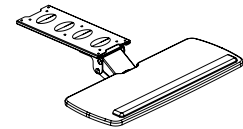

Articulating Keyboard Tray

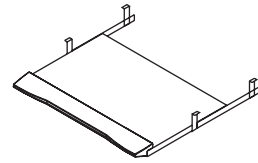

Retractable Laminate Keyboard Tray

What's Included:

Keyboard Tray, installation hardware.

How to Specify:

Specify laminate color for retractable keyboard. The vinyl trim color will default to match the laminate color unless otherwise specified. See the laminate finish card for details.

For articulating keyboard with mouse, right or left hand must be specified.

The articulating keyboards are available only in black.

Notes:

Keyboard trays provide adjustable ergonomic support for individuals in multi-task environments

Options:

Finish:	laminate colors (retractable keyboard only)		
Hand:	R right	L left (for adjustable keyboard with mouse only)	

Code	Price	H (in.)	W (in.)	Weight (lb)	Volume (ft ³)
Articulating Keyboard Tray w/Mouse Tray					
V-KAS0-2011-L	629	20	11	3	0.83
V-KAS0-2011-R	629	20	11	3	0.83
Articulating Keyboard Tray					
V-KASX-2510	403	25	10	15	0.94
Retractable Laminate Keyboard Tray					
V-KRS0-2516	264	25	10	12	0.94

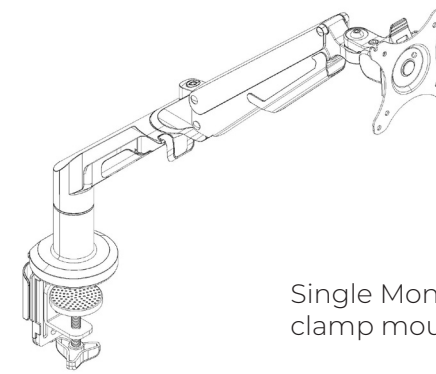

Single Monitor Arm - clamp mount

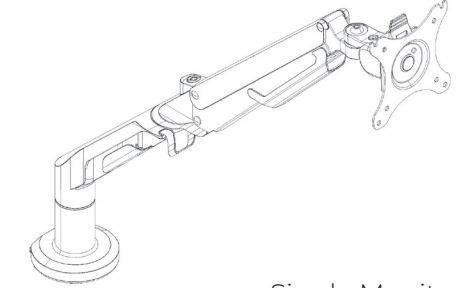

Single Monitor Arm - grommet mount

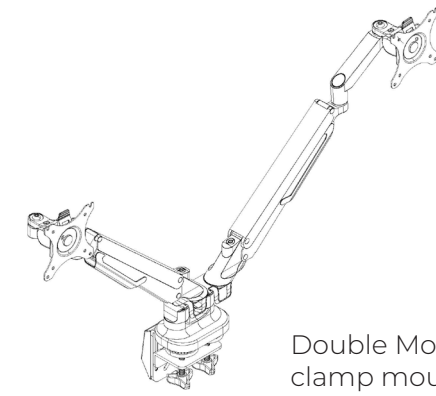

Double Monitor Arm - clamp mount

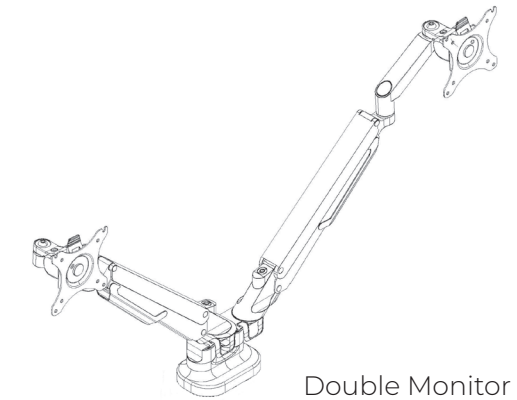

Double Monitor Arm - grommet mount

What's Included:

One monitor arm and installation hardware for both clamp and grommet mount

How to Specify:

- Specify type

Notes:

Available in silver only

Single Monitor Arm

- Screen Size - 17"-36"
- Load Capacity - 6.6-26.4lbs/3-12kg
- Tilt Range - -90 degrees - -15 degrees

Dual Monitor Arm

- Screen Size - 17"-32"
- Load Capacity - 4.4-19.8lbs/2-9kg
- Tilt Range - -90 degrees - -15 degrees

Dimensions:

Vesa: 75x75 and 100x100

Code	Price
Monitor Arm - Single Mount	
V-AFMA-01	374
Monitor Arm - Double Mount	
V-AFMA-02	624

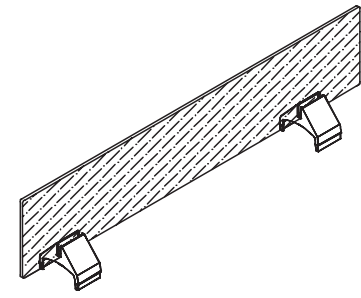

8-inch privacy screen

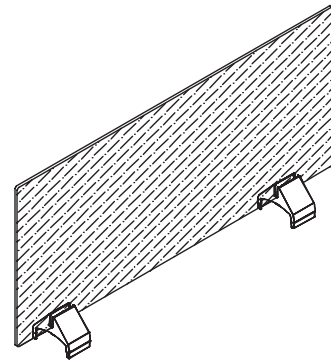

16-inch privacy screen

What's Included:

Top trim mounted privacy screen, two clamps.

How to Specify:

Specify metal color.

Specify the width of the top trim mounted privacy screen to be the same width of less than the panel frame that it is to be mounted to.

Notes:

The top trim mounted privacy screen is off-module and can be specified the same width as the worksurface it is to be mounted to, or smaller.

The top trim mounted privacy screen does not provide accoustical privacy.

The top trim mounted privacy screen is not load bearing.

60-inch top trim mounted privacy screens come with 3 clamps.

Options:

height	8, 16
width	18, 24, 30, 36, 42, 48, 54, 60
top screen finish	F frosted C clear
metal finish	metal colors

Code	Price	H (in.)	W (in.)	Weight (lb)	Volume (ft ³)	Code	Price	H (in.)	W (in.)	Weight (lb)	Volume (ft ³)
Frosted Acrylic						Clear Acrylic					
C-VGGP-0818-F	317	8	18	2.2	1	C-VGGP-0818-C	299	8	18	2.2	1
C-VGGP-0824-F	335	8	24	2.4	1.2	C-VGGP-0824-C	319	8	24	2.4	1.2
C-VGGP-0830-F	357	8	30	2.6	1.4	C-VGGP-0830-C	340	8	30	2.6	1.4
C-VGGP-0836-F	375	8	36	2.8	1.6	C-VGGP-0836-C	359	8	36	2.8	1.6
C-VGGP-0842-F	395	8	42	3	1.8	C-VGGP-0842-C	375	8	42	3	1.8
C-VGGP-0848-F	416	8	48	3.2	2	C-VGGP-0848-C	396	8	48	3.2	2
C-VGGP-0854-F	435	8	54	3.4	2.2	C-VGGP-0854-C	414	8	54	3.4	2.2
C-VGGP-0860-F	580	8	60	3.6	2.4	C-VGGP-0860-C	557	8	60	3.6	2.4
C-VGGP-1618-F	375	16	18	4.4	1.6	C-VGGP-1618-C	359	16	18	4.4	1.6
C-VGGP-1624-F	421	16	24	4.8	1.8	C-VGGP-1624-C	401	16	24	4.8	1.8
C-VGGP-1630-F	459	16	30	5.2	2	C-VGGP-1630-C	440	16	30	5.2	2
C-VGGP-1636-F	505	16	36	5.6	2.2	C-VGGP-1636-C	484	16	36	5.6	2.2
C-VGGP-1642-F	547	16	42	6	2.4	C-VGGP-1642-C	522	16	42	6	2.4
C-VGGP-1648-F	590	16	48	6.4	2.6	C-VGGP-1648-C	564	16	48	6.4	2.6
C-VGGP-1654-F	637	16	54	6.8	2.8	C-VGGP-1654-C	607	16	54	6.8	2.8
C-VGGP-1660-F	806	16	60	7.2	3	C-VGGP-1660-C	772	16	60	7.2	3

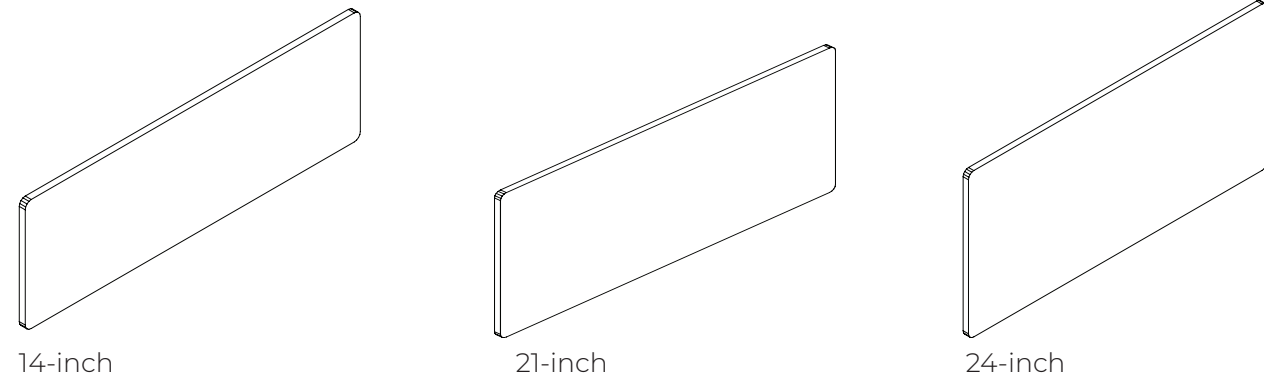

What's Included:

Wall mounted tackboard, fasteners.

How to Specify:

Specify fabric.

Notes:

The wall mounted tackboard mounts to a wall in the workspace to provide a fabric wrapped tackable surface.

Options:

height	14, 21, 24
width	24, 30, 36, 42, 48, 54, 60, 66, 72, 78, 84, 90, 96
screen finish	panel fabrics

Code	Price	H (in.)	W (in.)	Weight (lb)	Volume (ft ³)
V-ATW0-1424-1	117	14	24	1.2	0.19
V-ATW0-1430-1	126	14	30	1.5	0.24
V-ATW0-1436-1	156	14	36	1.9	0.29
V-ATW0-1442-1	165	14	42	2.2	0.34
V-ATW0-1448-1	171	14	48	2.5	0.39
V-ATW0-1454-1	181	14	54	2.8	0.44
V-ATW0-1460-1	190	14	60	3.1	0.49
V-ATW0-1466-1	240	14	66	3.4	0.54
V-ATW0-1472-1	259	14	72	3.7	0.59
V-ATW0-1478-1	354	14	78	4	0.64
V-ATW0-1484-1	363	14	84	4.3	0.69
V-ATW0-1496-1	375	14	96	4.6	0.79
V-ATW0-2124-1	176	21	24	1.8	0.28
V-ATW0-2130-1	189	21	30	2.25	0.36
V-ATW0-2142-1	248	21	42	3.3	0.51
V-ATW0-2148-1	257	21	48	3.75	0.58
V-ATW0-2154-1	271	21	54	4.2	0.66
V-ATW0-2160-1	284	21	60	4.65	0.73
V-ATW0-2166-1	358	21	66	5.1	0.81
V-ATW0-2172-1	388	21	72	5.55	0.89
V-ATW0-2178-1	531	21	78	6	0.96
V-ATW0-2184-1	546	21	84	6.45	1.03
V-ATW0-2196-1	564	21	96	7.35	1.19
V-ATW0-2424-1	199	24	24	2.05	0.32
V-ATW0-2430-1	214	24	30	2.56	0.41
V-ATW0-2436-1	266	24	36	3.25	0.5
V-ATW0-2442-1	281	24	42	3.76	0.58
V-ATW0-2448-1	290	24	48	4.28	0.67
V-ATW0-2454-1	307	24	54	4.79	0.75
V-ATW0-2460-1	323	24	60	5.3	0.84
V-ATW0-2466-1	406	24	66	5.81	0.92
V-ATW0-2472-1	440	24	72	6.33	1.01
V-ATW0-2478-1	602	24	78	6.84	1.09
V-ATW0-2484-1	617	24	84	7.35	1.18
V-ATW0-2490-1	629	24	90	7.87	1.27
V-ATW0-2496-1	639	24	96	8.38	1.35

Code	Price	H (in.)	W (in.)	Weight (lb)	Volume (ft ³)
V-ATW0-1424-2	149	14	24	1.2	0.19
V-ATW0-1430-2	158	14	30	1.5	0.24
V-ATW0-1436-2	220	14	36	1.9	0.29
V-ATW0-1442-2	230	14	42	2.2	0.34
V-ATW0-1448-2	234	14	48	2.5	0.39
V-ATW0-1454-2	245	14	54	2.8	0.44
V-ATW0-1460-2	254	14	60	3.1	0.49
V-ATW0-1466-2	335	14	66	3.4	0.54
V-ATW0-1472-2	356	14	72	3.7	0.59
V-ATW0-1478-2	451	14	78	4	0.64
V-ATW0-1484-2	459	14	84	4.3	0.69
V-ATW0-1490-2	465	14	90	4.6	0.74
V-ATW0-1496-2	504	14	96	4.9	0.79
V-ATW0-2124-2	208	21	24	1.8	0.28
V-ATW0-2130-2	220	21	30	2.25	0.36
V-ATW0-2136-2	299	21	36	2.85	0.43
V-ATW0-2142-2	313	21	42	3.3	0.51
V-ATW0-2148-2	321	21	48	3.75	0.58
V-ATW0-2154-2	336	21	54	4.2	0.66
V-ATW0-2160-2	349	21	60	4.65	0.73
V-ATW0-2166-2	454	21	66	5.1	0.81
V-ATW0-2172-2	485	21	72	5.55	0.89
V-ATW0-2178-2	628	21	78	6	0.96
V-ATW0-2184-2	641	21	84	6.45	1.03
V-ATW0-2190-2	651	21	90	6.9	1.11
V-ATW0-2196-2	692	21	96	7.35	1.19
V-ATW0-2424-2	231	24	24	2.05	0.32
V-ATW0-2430-2	246	24	30	2.56	0.41
V-ATW0-2436-2	330	24	36	3.25	0.5
V-ATW0-2442-2	346	24	42	3.76	0.58
V-ATW0-2448-2	354	24	48	4.28	0.67
V-ATW0-2454-2	372	24	54	4.79	0.75
V-ATW0-2460-2	387	24	60	5.3	0.84
V-ATW0-2466-2	501	24	66	5.81	0.92
V-ATW0-2472-2	536	24	72	6.33	1.01
V-ATW0-2478-2	697	24	78	6.84	1.09
V-ATW0-2484-2	713	24	84	7.35	1.18
V-ATW0-2490-2	725	24	90	7.87	1.27
V-ATW0-2496-2	767	24	96	8.38	1.35

Code	Price	H (in.)	W (in.)	Weight (lb)	Volume (ft ³)
V-ATW0-1424-3	181	14	24	1.2	0.19
V-ATW0-1430-3	190	14	30	1.5	0.24
V-ATW0-1436-3	284	14	36	1.9	0.29
V-ATW0-1442-3	294	14	42	2.2	0.34
V-ATW0-1448-3	299	14	48	2.5	0.39
V-ATW0-1454-3	310	14	54	2.8	0.44
V-ATW0-1460-3	318	14	60	3.1	0.49
V-ATW0-1466-3	431	14	66	3.4	0.54
V-ATW0-1472-3	452	14	72	3.7	0.59
V-ATW0-1478-3	547	14	78	4	0.64
V-ATW0-1484-3	555	14	84	4.3	0.69
V-ATW0-1490-3	562	14	90	4.6	0.74
V-ATW0-1496-3	568	14	96	4.9	0.79
V-ATW0-2124-3	241	21	24	1.8	0.28
V-ATW0-2130-3	253	21	30	2.25	0.36
V-ATW0-2136-3	363	21	36	2.85	0.43
V-ATW0-2142-3	376	21	42	3.3	0.51
V-ATW0-2148-3	385	21	48	3.75	0.58
V-ATW0-2154-3	400	21	54	4.2	0.66
V-ATW0-2160-3	412	21	60	4.65	0.73
V-ATW0-2166-3	550	21	66	5.1	0.81
V-ATW0-2172-3	581	21	72	5.55	0.89
V-ATW0-2178-3	723	21	78	6	0.96
V-ATW0-2184-3	738	21	84	6.45	1.03
V-ATW0-2190-3	746	21	90	6.9	1.11
V-ATW0-2196-3	757	21	96	7.35	1.19
V-ATW0-2424-3	264	24	24	2.05	0.32
V-ATW0-2430-3	279	24	30	2.56	0.41
V-ATW0-2436-3	394	24	36	3.25	0.5
V-ATW0-2442-3	409	24	42	3.76	0.58
V-ATW0-2448-3	419	24	48	4.28	0.67
V-ATW0-2454-3	436	24	54	4.79	0.75
V-ATW0-2460-3	452	24	60	5.3	0.84
V-ATW0-2466-3	598	24	66	5.81	0.92
V-ATW0-2472-3	632	24	72	6.33	1.01
V-ATW0-2478-3	794	24	78	6.84	1.09
V-ATW0-2484-3	809	24	84	7.35	1.18
V-ATW0-2490-3	820	24	90	7.87	1.27
V-ATW0-2496-3	831	24	96	8.38	1.35

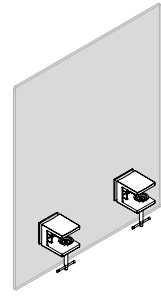

worksurface edge mounted screen

What's Included:

Worksurface edge mounted screen, two clamps.

How to Specify:

The worksurface edge mounted screen is off-module and can be specified the same width as the worksurface it is to be mounted to, or smaller.

The worksurface edge mounted screen does not provide accoustical privacy.

Notes:

The clamps on the worksurface edge mounted screens are finished in silver only.

Specify the width of the worksurface screen to be the same width or less than the worksurface or table that it is to be mounted to.

Options:

width 24, 30, 36, 42, 48, 54, 60, 66, 72, 78, 84, 90

screen finish **F** - frosted

metal finish **P112** silver

Code	Price	H (in.)	W (in.)	Weight (lb)	Volume (ft ³)
C-VGGW-24-F	349	24	312	24	5.78
C-VGGW-30-F	414	24	382	30	7.1
C-VGGW-36-F	477	24	452	36	8.43
C-VGGW-42-F	540	24	522	42	9.75
C-VGGW-48-F	605	24	594	48	11.08
C-VGGW-54-F	667	24	665	54	12.4
C-VGGW-60-F	735	24	735	60	13.73
C-VGGW-66-F	863	24	848	66	15.06
C-VGGW-72-F	925	24	917	72	16.4
C-VGGW-78-F	990	24	989	78	17.72
C-VGGW-84-F	1053	24	1059	84	19.05
C-VGGW-90-F	1118	24	1129	90	20.38

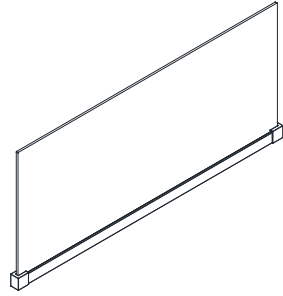

What's Included:

Panel mounted acrylic screen, installation hardware. .

How to Specify:

Specify metal color.

Specify the width of the panel top mounted privacy screen to be the same width of the panel frame that it is to be mounted to.

Notes:

The panel top mounted privacy screen is on-module to panel frames of the same width.

The panel top mounted privacy screen does not provide accoustical privacy.

Double span panel top mounted privacy screen can be placed across the width of two equal sized panels

Options:

height	8, 16
width	18, 24, 30, 36, 42, 48, 54, 60
finish	F frosted acrylic C clear acrylic C-G clear glass F-G frosted glass
metal	metal colors

Code	Price	H (in.)	W (in.)	Weight (lb)	Volume (ft ³)
Clear Acrylic					
C-VUCP-0818-C	466	8	18	2.2	0.17
C-VUCP-0824-C	487	8	24	2.4	0.22
C-VUCP-0830-C	514	8	30	2.6	0.28
C-VUCP-0836-C	563	8	36	2.8	0.33
C-VUCP-0842-C	602	8	42	3	0.39
C-VUCP-0848-C	607	8	48	3.2	0.44
C-VUCP-0854-C	655	8	54	3.4	0.5
C-VUCP-0860-C	663	8	60	3.6	0.56
C-VUCP-1618-C	504	16	18	4.4	0.33
C-VUCP-1624-C	528	16	24	4.8	0.44
C-VUCP-1630-C	561	16	30	5.2	0.56
C-VUCP-1636-C	613	16	36	5.6	0.67
C-VUCP-1642-C	654	16	42	6	0.78
C-VUCP-1648-C	663	16	48	6.4	0.89
C-VUCP-1654-C	714	16	54	6.8	1
C-VUCP-1660-C	719	16	60	7.2	1.11
Double Span Clear Acrylic					
C-VUCP-0872-C	721	8	72	4	0.68
C-VUCP-1672-C	783	16	72	8	1.33

Code	Price	H (in.)	W (in.)	Weight (lb)	Volume (ft ³)
Frosted Acrylic					
C-VUCP-0818-F	602	8	18	2.2	0.17
C-VUCP-0824-F	631	8	24	2.4	0.22
C-VUCP-0830-F	668	8	30	2.6	0.28
C-VUCP-0836-F	730	8	36	2.8	0.33
C-VUCP-0842-F	783	8	42	3	0.39
C-VUCP-0848-F	791	8	48	3.2	0.44
C-VUCP-0854-F	853	8	54	3.4	0.5
C-VUCP-0860-F	860	8	60	3.6	0.56
C-VUCP-1618-F	654	16	18	4.4	0.33
C-VUCP-1624-F	688	16	24	4.8	0.44
C-VUCP-1630-F	727	16	30	5.2	0.56
C-VUCP-1636-F	795	16	36	5.6	0.67
C-VUCP-1642-F	851	16	42	6	0.78
C-VUCP-1648-F	860	16	48	6.4	0.89
C-VUCP-1654-F	929	16	54	6.8	1
C-VUCP-1660-F	934	16	60	7.2	1.11
Double Span Frosted Acrylic					
C-VUCP-0872-F	936	8	72	4	0.68
C-VUCP-1672-F	1018	16	72	8	1.33

Code	Price	H (in.)	W (in.)	Weight (lb)	Volume (ft ³)
Clear Tempered Glass					
C-VUCP-0818-C-G	466	8	18	3.4	0.17
C-VUCP-0824-C-G	487	8	24	4.53	0.22
C-VUCP-0830-C-G	514	8	30	5.67	0.28
C-VUCP-0836-C-G	563	8	36	6.8	0.33
C-VUCP-0842-C-G	602	8	42	7.93	0.39
C-VUCP-0848-C-G	607	8	48	9.07	0.44
C-VUCP-0854-C-G	655	8	54	10.2	0.5
C-VUCP-0860-C-G	666	8	60	11.33	0.56
C-VUCP-1618-C-G	504	16	18	6.8	0.33
C-VUCP-1624-C-G	528	16	24	9.07	0.44
C-VUCP-1630-C-G	561	16	30	11.33	0.56
C-VUCP-1636-C-G	613	16	36	13.6	0.67
C-VUCP-1642-C-G	654	16	42	15.87	0.78
C-VUCP-1648-C-G	663	16	48	18.13	0.89
C-VUCP-1654-C-G	714	16	54	20.4	1
C-VUCP-1660-C-G	719	16	60	22.67	1.11
Double Span Clear Tempered Glass					
C-VUCP-0872-C-G	721	8	72	13.59	0.68
C-VUCP-1672-C-G	783	16	72	27.21	1.33

Code	Price	H (in.)	W (in.)	Weight (lb)	Volume (ft ³)
Frosted Tempered Glass					
C-VUCP-0818-F-G	602	8	18	3.4	0.17
C-VUCP-0824-F-G	631	8	24	4.53	0.22
C-VUCP-0830-F-G	668	8	30	5.67	0.28
C-VUCP-0836-F-G	730	8	36	6.8	0.33
C-VUCP-0842-F-G	783	8	42	7.93	0.39
C-VUCP-0848-F-G	791	8	48	9.07	0.44
C-VUCP-0854-F-G	853	8	54	10.2	0.5
C-VUCP-0860-F-G	860	8	60	11.33	0.56
C-VUCP-1618-F-G	654	16	18	6.8	0.33
C-VUCP-1624-F-G	688	16	24	9.07	0.44
C-VUCP-1630-F-G	727	16	30	11.33	0.56
C-VUCP-1636-F-G	795	16	36	13.6	0.67
C-VUCP-1642-F-G	851	16	42	15.87	0.78
C-VUCP-1648-F-G	860	16	48	18.13	0.89
C-VUCP-1654-F-G	929	16	54	20.4	1
C-VUCP-1660-F-G	934	16	60	22.67	1.11
Double Span Frosted Tempered Glass					
C-VUCP-0872-F-G	936	8	72	13.59	0.68
C-VUCP-1672-F-G	1018	16	72	27.21	1.33



Cosmo Pricebook
August 2024
Electrics
Communication
Lighting

electrics, communication, lighting

task light	188
power modules	189
electric starter harness	190
monitor arm	191
communication kit	191
power pole	192
belt-line electrics power module	194
horizontal wire manager	195
connector harness	196
male/female extension harness	198

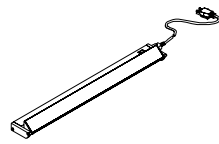

What's Included:

Task Light, installation hardware.

How to Specify:

This product is available only in silver.

Options:

width 24, 36, 48

Notes:

The task light can be mounted beneath an overhead cabinet or shelf to provide focused lighting within the workstation.

The task light cord is 9-feet long from the end of the task light.

Code	Price	H (in.)	W (in.)	D 1 (in.)	Weight (lb)	Volume (ft ³)
V-ELU-24	302	1.1	24.53	3.5	9.5	0.16
V-ELU-36	340	1.1	36.34	3.5	13.7	0.27
V-ELU-48	427	1.1	48.15	3.5	17.9	0.38

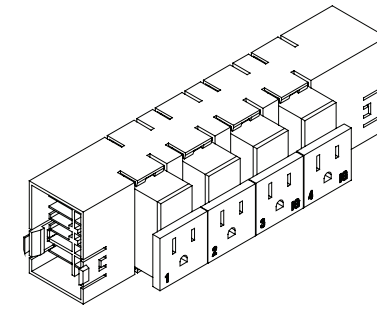

single sided

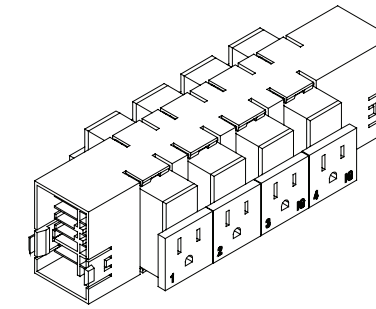

double sided

What's Included:

Base electrics power module as specified.

How to Specify:

This product is available only in black.

Notes:

8 wire 4 circuit electrical system.

The base electrics power module can be retrofitted into the base raceway of existing Cosmo panel frames.

Base electrics power modules can be single-sided or double-sided.

18-inch wide panel frame does not accommodate a base power module.

24-inch wide panel frames placed side-by-side only accommodates one base power module in one panel.

24-inch wide panel frame with base power module does not accommodate base data/communication kits.

Options:

type **S** single-sided **D** double-sided

Code	Price	Weight (lb)	Volume (ft ³)
Single sided			
C-EM84-S	222	1.7	0.2
Double sided			
C-EM84-D	357	2	0.2

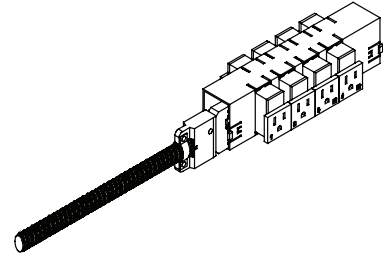

What's Included:

Electric Starter Harness, as specified.

How to Specify:

This product is available only in black.

Options:

configuration	B14 4 outlets (14")	B20 8 outlets (20")
accessibility	S single-sided	D - double-sided

Notes:

8 wire 4 circuit electrical system.

The starter harness is available in 72-inch and 168-inch lengths.

Code	Price	Weight (lb)	Volume (ft ³)
Base-line			
C-ES84-072-S	523	2.48	0.4
C-ES84-168-S	689	5.12	0.4
C-ES84-072-D	656	2.28	0.4
C-ES84-168-D	824	5.22	0.4
Belt-line			
C-ES84-072-B14	714	3.28	0.4
C-ES84-168-B14	882	4.48	0.4
C-ES84-072-B20	831	3.48	0.4
C-ES84-168-B20	999	5.22	0.4

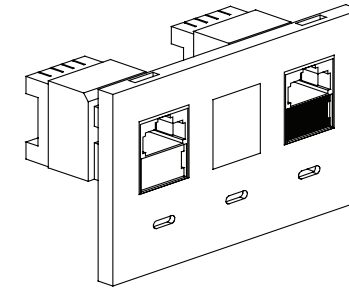

ECK1

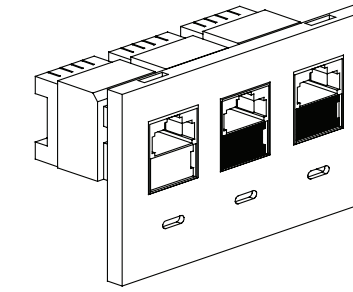

ECK2

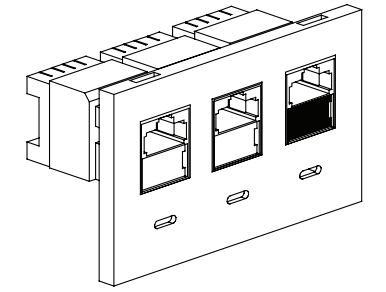

ECK23

What's Included:

Communication kit, face plate, and jacks, as specified.

How to Specify:

This product is available only in black.

Specify configuration.

Options:

configuration	1 config 1	2 config 2	3 config 3
type	base-line		B belt-line

Notes:

Config 1: one communication outlet (RJ11), one data outlet (RJ45)

Config 2: two communication outlets (RJ11), one data outlet (RJ45)

Config 3: one communication outlet (RJ11), two data outlets (RJ45)

Code	Price	Weight (lb)	Volume (ft ³)
Base-line			
C-ECK1	161	0.24	0.2
C-ECK2	197	0.34	0.2
C-ECK3	246	0.34	0.2
Belt-line			
C-ECK1-B	207	0.24	0.2
C-ECK2-B	241	0.34	0.2
C-ECK3-B	293	0.34	0.2

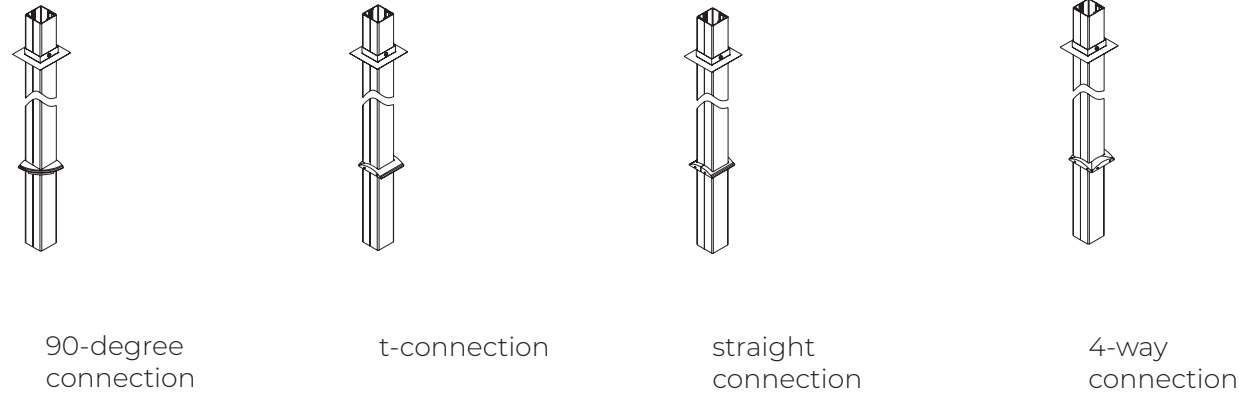

What's Included:

Power pole, top cap, ceiling grommet.

How to Specify:

Specify vinyl color.

Refer to the vinyl/metal finish card for details.

Notes:

8 wire 4 circuit electrical system.

The vinyl power pole attaches to cosmo panel connectors in 90-degree connections, T-connections, straight connections or 4-way connections.

144-inch power poles have the option of being divided.

Options:

type	D - divided	O - non-divided
height	72, 144	
connection	N 90-degree connection	T t-connection
	S straight connection	4 4-way connection
finish	vinyl colors	

Code	Price	Weight (lb)	Volume (ft ³)
90-degree connection			
C-EPVD-144-N	375	6	1.5
C-EPV0-072-N	220	3	1
C-EPV0-144-N	342	6	1.5
t-connection			
C-EPVD-144-T	375	6	1.5
C-EPV0-072-T	220	3	1
C-EPV0-144-T	342	6	1.5
straight connection			
C-EPVD-144-S	375	6	1.5
C-EPV0-072-S	220	3	1
C-EPV0-144-S	342	6	1.5
4-way connection			
C-EPVD-144-4	375	6	1.5
C-EPV0-072-4	220	3	1
C-EPV0-144-4	342	6	1.5

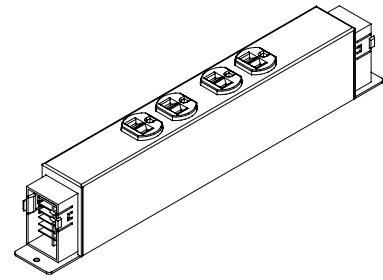

4 outlets

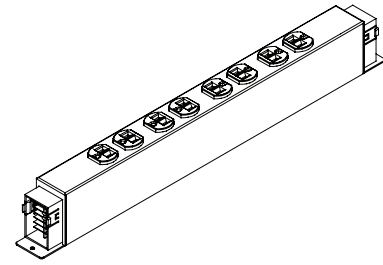

8 outlets

What's Included:

Belt-line electrics power module as specified.

How to Specify:

This product is available only in black.

Notes:

8 wire 4 circuit electrical system.

Belt-line electrics power modules are available with four outlets or eight outlets.

18-inch and 24-inch wide panel frames do not accommodate a belt-line power module.

30-inch wide panel frame accommodates belt-line power module with 4 outlets only.

30-inch wide panel frames placed side-by-side can only accommodate one 4 outlet module in one of the panel frames.

30-inch wide panel frame with a belt-line power module does not accommodate belt-line data/communication kits.

36-inch wide panel frame with a belt-line power module (8 outlets) does not accommodate belt-line data/communication kits.

Options:

type **B14** 4 outlets (14") **B20** 8 outlets (20")

Code	Price	Weight (lb)	Volume (ft ³)
4 outlets			
C-EM84-B14	414	2	0.2
8 outlets			
C-EM84-B20	531	2.7	0.2

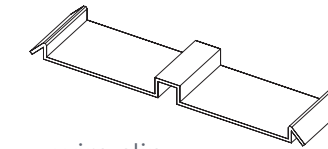
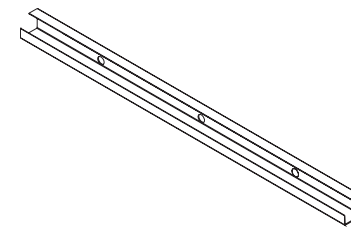

wire clip

What's Included:

Wire Manager, installation hardware.

How to Specify:

Specify the length of the wire manager to be 6-inches less than the width of the workstation to which it will be mounted.

Notes:

The horizontal wire manager attaches to the underside of a worksurface.

Options:

width 12, 18, 24, 30, 36, 42, 48, 54, 60, 66, 72

Code	Price	W (in.)	Weight (lb)	Volume (ft ³)
horizontal wire manager				
V-EWHB-12	8	12	0.15	0.1
V-EWHB-18	12	18	0.25	0.15
V-EWHB-24	16	24	0.35	0.2
V-EWHB-30	20	30	0.45	0.25
V-EWHB-36	23	36	0.55	0.3
V-EWHB-42	27	42	0.65	0.35
V-EWHB-48	30	48	0.75	0.4
V-EWHB-54	33	54	0.85	0.45
V-EWHB-60	37	60	0.95	0.5
V-EWHB-66	41	66	1.05	0.55
V-EWHB-72	43	72	1.15	0.6
worksurface wire clips				
V-EWHC	39			

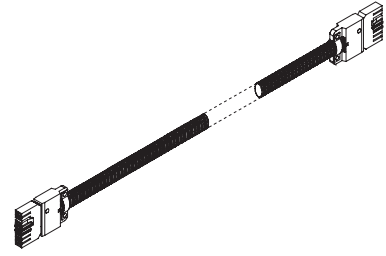

What's Included:

Connector Harness, as specified.

How to Specify:

Options:

length 22, 25, 28, 31, 34, 37, 40, 43, 46, 49, 52, 55, 58, 61, 64, 67, 70, 73, 76, 79, 82, 85, 88, 91, 94, 97, 100, 103, 106, 109, 112, 115, 118, 121, 124, 127, 130, 133, 136, 139, 142, 145, 148, 151, 154, 157, 160, 163, 166, 169, 172, 175, 178, 181

Notes:

8 wire 4 circuit electrical system.
 The connector harness is equipped with two male ends.
 Connector harnesses, 148-inches and longer are comprised of two pieces connected together.

Code	Price	L (in.)	Weight (lb)	Volume (ft ³)	Code	Price	L (in.)	Weight (lb)	Volume (ft ³)
one piece harness					C-EH84-103	329	103	2.7	0.2
C-EH84-22	167	22	0.6	0.2	C-EH84-106	336	106	2.86	0.2
C-EH84-25	174	25	0.7	0.2	C-EH84-109	342	109	2.86	0.2
C-EH84-28	178	28	0.8	0.2	C-EH84-112	348	112	3.03	0.2
C-EH84-31	187	31	0.8	0.2	C-EH84-115	354	115	3.03	0.2
C-EH84-34	191	34	0.9	0.2	C-EH84-118	361	118	3.19	0.2
C-EH84-37	197	37	1	0.2	C-EH84-121	366	121	3.36	0.2
C-EH84-40	207	40	1.1	0.2	C-EH84-124	371	124	3.36	0.2
C-EH84-43	210	43	1.2	0.2	C-EH84-127	381	127	3.52	0.2
C-EH84-46	214	46	1.3	0.2	C-EH84-130	385	130	3.52	0.2
C-EH84-49	219	49	1.5	0.2	C-EH84-133	388	133	3.39	0.2
C-EH84-52	228	52	1.5	0.2	C-EH84-136	398	136	3.69	0.2
C-EH84-55	234	55	1.6	0.2	C-EH84-139	403	139	3.85	0.2
C-EH84-58	241	58	1.7	0.2	C-EH84-142	408	142	3.85	0.2
C-EH84-61	244	61	1.8	0.2	C-EH84-145	416	145	3.85	0.2
C-EH84-64	252	64	1.9	0.2	two piece harnesses				
C-EH84-67	259	67	1.9	0.2	C-EH84-148	557	148	3.85	0.2
C-EH84-70	264	70	2	0.2	C-EH84-151	562	151	4.18	0.2
C-EH84-73	271	73	1.95	0.2	C-EH84-154	567	154	4.26	0.2
C-EH84-76	277	76	2.04	0.2	C-EH84-157	575	157	4.35	0.2
C-EH84-79	281	79	2.12	0.2	C-EH84-160	579	160	4.43	0.2
C-EH84-82	287	82	2.12	0.2	C-EH84-163	582	163	4.51	0.2
C-EH84-85	294	85	2.37	0.2	C-EH84-166	590	166	4.59	0.2
C-EH84-88	299	88	2.37	0.2	C-EH84-169	598	169	4.68	0.2
C-EH84-91	305	91	2.37	0.2	C-EH84-172	603	172	4.76	0.2
C-EH84-94	311	94	2.53	0.2	C-EH84-175	611	175	4.84	0.2
C-EH84-97	319	97	2.53	0.2	C-EH84-178	617	178	4.92	0.2
C-EH84-100	324	100	2.7	0.2	C-EH84-181	622	181	5.01	0.2

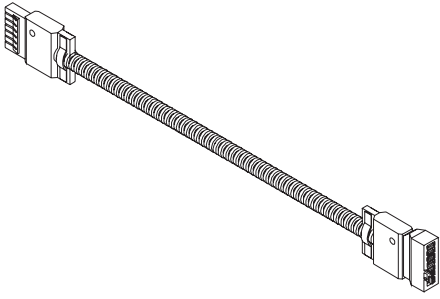

What's Included:

Harness, as specified.

How to Specify:

This product is available only in black.

Notes:

8 wire 4 circuit electrical system.

The harness is equipped with one male end and one female end. The harness connects connector harnesses to electrical power modules.

Options:

length 44, 122

Code	Price	L (in.)	Weight (lb)	Volume (ft ³)
C-E8FM-044	214	44	0.3	0.2
C-E8FM-122	371	122	0.6	0.2